

MCV/Q

MEDICAL COLLEGE OF VIRGINIA QUARTERLY
VOLUME TEN • NUMBER ONE • 1974



**IMMUNOLOGY
AND RHEUMATIC DISEASES**

PART I

When cardiac complaints occur in the absence of organic findings, underlying anxiety may be one factor

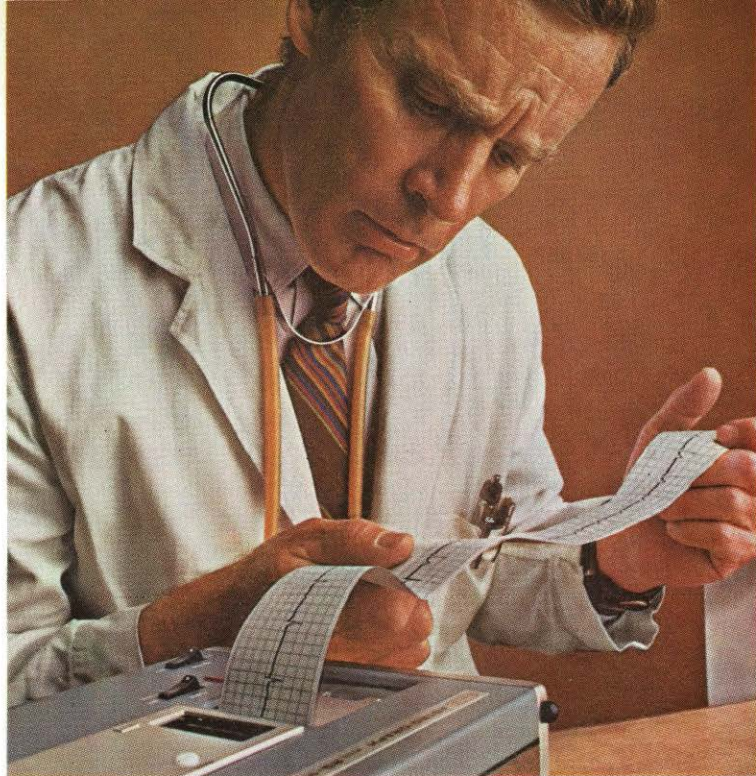

The influence of anxiety on heart function

Excessive anxiety is one of a combination of factors that may trigger a series of maladaptive functional reactions which can generate further anxiety. Often involved in this vicious circle are some cardiac arrhythmias, paroxysmal supraventricular tachycardia and premature systoles. When these symptoms resemble those associated with actual organic disease, the overanxious patient needs reassurance that they have no

Before prescribing, please consult complete product information, a summary of which follows:

Indications: Relief of anxiety and tension occurring alone or accompanying various disease states.

Contraindications: Patients with known hypersensitivity to the drug.

Warnings: Caution patients about possible combined effects with alcohol and other CNS depressants. As with all CNS-acting drugs, caution patients against hazardous occupations requiring complete mental alertness (*e.g.*, operating machinery, driving). Though physical and psychological dependence have rarely been reported on recommended doses, use caution in administering to addiction-prone individuals or those who might increase dosage; withdrawal symptoms (including convulsions), following discontinuation of the drug and similar to those seen with barbiturates, have been reported. Use of any drug in pregnancy, lactation, or in women of childbearing age requires that its potential benefits be weighed against its possible hazards.

Precautions: In the elderly and debilitated, and in children over six, limit to smallest effective dosage (initially 10 mg or less per day) to preclude ataxia or oversedation, increasing gradually as needed and tolerated. Not recommended in children under six. Though generally not recommended, if combination therapy with other psychotropics seems indicated, carefully consider individual pharmacologic effects, particularly in use of potentiating drugs such as MAO inhibitors and phenothiazines. Observe usual precautions

organic basis and that reduction of excessive anxiety and emotional overreaction would be medically beneficial.

The benefits of antianxiety therapy

Antianxiety medication, when used to complement counseling and reassurance, should be both effective and comparatively free from undesirable side effects. More than 13 years of extensive clinical experience has demonstrated that Librium (chlordiazepoxide HCl) fulfills these requirements with a high degree of consistency. Because of its wide margin of safety, Librium may generally be administered for extended periods, at the physician's discretion, without diminution of effect or need for increase in dosage. (See summary of prescribing information.) If cardiovascular drugs are necessary, Librium is used concomitantly whenever anxiety is a clinically significant factor. (See Precautions.) Librium should be discontinued when anxiety has been reduced to appropriate levels.

For relief of
excessive anxiety
adjunctive

Librium® 10 mg
(chlordiazepoxide HCl)
1 or 2 capsules t.i.d./q.i.d.



Roche Laboratories
Division of Hoffmann-La Roche Inc.
Nutley, N.J. 07110

in presence of impaired renal or hepatic function. Paradoxical reactions (*e.g.*, excitement, stimulation and acute rage) have been reported in psychiatric patients and hyperactive aggressive children. Employ usual precautions in treatment of anxiety states with evidence of impending depression; suicidal tendencies may be present and protective measures necessary. Variable effects on blood coagulation have been reported very rarely in patients receiving the drug and oral anticoagulants; causal relationship has not been established clinically.

Adverse Reactions: Drowsiness, ataxia and confusion may occur, especially in the elderly and debilitated. These are reversible in most instances by proper dosage adjustment, but are also occasionally observed at the lower dosage ranges. In a few instances syncope has been reported. Also encountered are isolated instances of skin eruptions, edema, minor menstrual irregularities, nausea and constipation, extrapyramidal symptoms, increased and decreased libido—all infrequent and generally controlled with dosage reduction; changes in EEG patterns (low-voltage fast activity) may appear during and after treatment; blood dyscrasias (including agranulocytosis), jaundice and hepatic dysfunction have been reported occasionally, making periodic blood counts and liver function tests advisable during protracted therapy.

Supplied: Librium® Capsules containing 5 mg, 10 mg or 25 mg chlordiazepoxide HCl. Libritabs® Tablets containing 5 mg, 10 mg or 25 mg chlordiazepoxide.





the long-range analgesic

in chronic pain: continued relief without risk of tolerance

Though Talwin® Tablets can be compared to codeine in analgesic efficacy, Talwin is not subject to narcotic controls. For patients who require potent analgesia for prolonged periods, Talwin can provide consistent, long-range relief, with fewer of the consequences you've come to expect with narcotic analgesics.

- **Comparable to codeine in analgesic efficacy:** one 50 mg. Talwin Tablet appears equivalent in analgesic effect to 60 mg. (1 gr.) of codeine. Onset of significant analgesia usually occurs within 15 to 30 minutes. Analgesia is usually maintained for 3 hours or longer.

- **Tolerance not a problem:** tolerance to the analgesic effect of Talwin Tablets has not been reported, and no significant changes in clinical laboratory parameters attributable to the drug have been reported.

- **Dependence rarely a problem:** during three years of wide clinical use, only a few cases of dependence have been reported. *In prescribing Talwin for chronic use, the physician should take precautions to avoid increases in dose by the patient and to prevent the use of the drug in anticipation of pain rather than for the relief of pain.* (See last page for a complete discussion of Warnings under Brief Summary.)

- **Generally well tolerated by most patients:** infrequently cause decrease in blood pressure or tachycardia; rarely cause respiratory depression or urinary retention; seldom cause diarrhea or constipation. If dizziness, lightheadedness, nausea or vomiting are encountered, these effects may decrease or disappear after the first few doses. (See last page of this advertisement for a complete discussion of Adverse Reactions and a Brief Summary of other Prescribing Information.)

50 mg. Tablets

Talwin®
brand of
pentazocine (as hydrochloride)

in moderate to severe pain

the long-range analgesic

in chronic pain: continued relief without risk of tolerance

Though Talwin® Tablets can be compared to codeine in analgesic efficacy, Talwin is not subject to narcotic controls. For patients who require potent analgesia for prolonged periods, Talwin can provide consistent, long-range relief, with fewer of the consequences you've come to expect with narcotic analgesics.

• **Comparable to codeine in analgesic efficacy:** one 50 mg. Talwin Tablet appears equivalent in analgesic effect to 60 mg. (1 gr.) of codeine. Onset of significant analgesia usually occurs within 15 to 30 minutes. Analgesia is usually maintained for 3 hours or longer.

• **Tolerance not a problem:** tolerance to the analgesic effect of Talwin Tablets has not been reported, and no significant changes in clinical laboratory parameters attributable to the drug have been reported.

• **Dependence rarely a problem:** during three years of wide clinical use, only a few cases of dependence have been reported. *In prescribing Talwin for chronic use, the physician should take precautions to avoid increases in dose by the patient and to prevent the use of the drug in anticipation of pain rather than for the relief of pain.* (See last page for a complete discussion of Warnings under Brief Summary.)

• **Generally well tolerated by most patients:** infrequently cause decrease in blood pressure or tachycardia; rarely cause respiratory depression or urinary retention; seldom cause diarrhea or constipation. If dizziness, lightheadedness, nausea or vomiting are encountered, these effects may decrease or disappear after the first few doses. (See last page of this advertisement for a complete discussion of Adverse Reactions and a Brief Summary of other Prescribing Information.)

50 mg. Tablets

Talwin®
brand of
pentazocine (as hydrochloride)

in moderate to severe pain



the long-range analgesic

in chronic pain: continued
relief without risk of tolerance

**Talwin® Tablets brand of pentazocine (as hydrochloride)
Analgesic for Oral Use—Brief Summary**

Indications: For the relief of moderate to severe pain.

Contraindication: Talwin should not be administered to patients who are hypersensitive to it.

Warnings: Drug Dependence. There have been instances of psychological and physical dependence on parenteral Talwin in patients with a history of drug abuse and, rarely, in patients without such a history. Abrupt discontinuance following the extended use of parenteral Talwin has resulted in withdrawal symptoms. There have been a few reports of dependence and of withdrawal symptoms with orally administered Talwin. Patients with a history of drug dependence should be under close supervision while receiving Talwin orally.

In prescribing Talwin for chronic use, the physician should take precautions to avoid increases in dose by the patient and to prevent the use of the drug in anticipation of pain rather than for the relief of pain.

Head Injury and Increased Intracranial Pressure. The respiratory depressant effects of Talwin and its potential for elevating cerebrospinal fluid pressure may be markedly exaggerated in the presence of head injury, other intracranial lesions, or a preexisting increase in intracranial pressure. Furthermore, Talwin can produce effects which may obscure the clinical course of patients with head injuries. In such patients, Talwin must be used with extreme caution and only if its use is deemed essential.

Usage in Pregnancy. Safe use of Talwin during pregnancy (other than labor) has not been established. Animal reproduction studies have not demonstrated teratogenic or embryotoxic effects. However, Talwin should be administered to pregnant patients (other than labor) only when, in the judgment of the physician, the potential benefits outweigh the possible hazards. Patients receiving Talwin during labor have experienced no adverse effects other than those that occur with commonly used analgesics. Talwin should be used with caution in women delivering premature infants.

Acute CNS Manifestations. Patients receiving therapeutic doses of Talwin have experienced, in rare instances, hallucinations (usually visual), disorientation, and confusion which have cleared spontaneously within a period of hours. The mechanism of this reaction is not known. Such patients should be very closely observed and vital signs checked. If the drug is reinstated it should be done with caution since the acute CNS manifestations may recur.

Usage in Children. Because clinical experience in children under 12 years of age is limited, administration of Talwin in this age group is not recommended.

Ambulatory Patients. Since sedation, dizziness, and occasional euphoria have been noted, ambulatory patients should be warned not to operate machinery, drive cars, or unnecessarily expose themselves to hazards.

Precautions: Certain Respiratory Conditions. Although respiratory depression has rarely been reported after oral administration of Talwin, the drug should be administered with caution to patients with respiratory depression from any cause, severe bronchial asthma and other obstructive respiratory conditions, or cyanosis.

Impaired Renal or Hepatic Function. Decreased metabolism of the drug by the liver in extensive liver disease may predispose to accentuation of side effects. Although laboratory tests have not indicated that Talwin causes or increases renal or hepatic impairment, the drug should be administered with caution to patients with such impairment.

Myocardial Infarction. As with all drugs, Talwin should be used with caution in patients with myocardial infarction who have nausea or vomiting.

Biliary Surgery. Until further experience is gained with the effects of Talwin on the sphincter of Oddi, the drug should be used with caution in patients about to undergo surgery of the biliary tract.

Patients Receiving Narcotics. Talwin is a mild narcotic antagonist. Some patients previously given narcotics, including methadone for the daily treatment of narcotic dependence, have experienced mild withdrawal symptoms after receiving Talwin.

CNS Effect. Caution should be used when Talwin is administered to patients prone to seizures; seizures have occurred in a few such patients in association with the use of Talwin although no cause and effect relationship has been established.

Adverse Reactions: Reactions reported after oral administration of Talwin include *gastrointestinal:* nausea, vomiting; infrequently constipation; and rarely abdominal distress, anorexia, diarrhea. *CNS effects:* dizziness, lightheadedness, sedation, euphoria, headache; infrequently weakness, disturbed dreams, insomnia, syncope, visual blurring and focusing difficulty, hallucinations (see *Acute CNS Manifestations* under **WARNINGS**); and rarely tremor, irritability, excitement, tinnitus. *Autonomic:* sweating; infrequently flushing; and rarely chills. *Allergic:* infrequently rash; and rarely urticaria, edema of the face. *Cardiovascular:* infrequently decrease in blood pressure, tachycardia. *Other:* rarely respiratory depression, urinary retention.

Dosage and Administration: Adults. The usual initial adult dose is 1 tablet (50 mg.) every three or four hours. This may be increased to 2 tablets (100 mg.) when needed. Total daily dosage should not exceed 600 mg.

When antiinflammatory or antipyretic effects are desired in addition to analgesia, aspirin can be administered concomitantly with Talwin.

Children Under 12 Years of Age. Since clinical experience in children under 12 years of age is limited, administration of Talwin in this age group is not recommended.

Duration of Therapy. Patients with chronic pain who have received Talwin orally for prolonged periods have not experienced withdrawal symptoms even when administration was abruptly discontinued (see **WARNINGS**). No tolerance to the analgesic effect has been observed. Laboratory tests of blood and urine and of liver and kidney function have revealed no significant abnormalities after prolonged administration of Talwin.

Overdosage: Manifestations. Clinical experience with Talwin overdosage has been insufficient to define the signs of this condition.

Treatment. Oxygen, intravenous fluids, vasopressors, and other supportive measures should be employed as indicated. Assisted or controlled ventilation should also be considered. Although nalorphine and levallorphan are not effective antidotes for respiratory depression due to overdosage or unusual sensitivity to Talwin, parenteral naloxone (Narcan®, available through Endo Laboratories) is a specific and effective antagonist.

Talwin is not subject to narcotic controls.

How Supplied: Tablets, peach color, scored. Each tablet contains Talwin (brand of pentazocine) as hydrochloride equivalent to 50 mg. base. Bottles of 100.

50 mg. Tablets

Talwin®
brand of
pentazocine (as hydrochloride)

in moderate to severe pain

Winthrop Winthrop Laboratories, New York, N.Y. 10016

(1607H)

Immunology
and the
Rheumatic
Diseases

MCV/Q

MEDICAL COLLEGE OF VIRGINIA QUARTERLY

*A Scientific Publication of the School of Medicine
Health Sciences Division of Virginia Commonwealth University*

1974 • Volume Ten • Number One

CONTENTS

MEDICAL COLLEGE OF VIRGINIA QUARTERLY Published quarterly (Spring, Summer, Fall, Winter), by the Medical College of Virginia, Division of Health Sciences, Virginia Commonwealth University. The QUARTERLY publishes results of original research in basic and clinical sciences. Contributions from outside the Medical College of Virginia faculty are invited. Manuscripts, submitted in duplicate, should be prepared according to recommendations in the Style Manual for Biological Journals, Washington, D.C., American Institute of Biological Sciences, Second Edition, 1964.

Correspondence: MEDICAL COLLEGE OF VIRGINIA QUARTERLY, Medical College of Virginia, Richmond, Virginia 23298. Phone 804/770-4027.

Subscription rates for U.S.A., Canada, and Mexico: 1 year, \$6.00; 2 years, \$10.00; 3 years, \$14.00. All other countries: 1 year, \$8.00; 2 years, \$12.00; 3 years, \$15.00. Libraries and institutions: (U.S.A.) 1 year, \$12.00; 2 years, \$20.00; 3 years, \$28.00; (foreign) 1 year, \$13.00; 2 years, \$21.00; 3 years, \$29.00. Interns, residents, and students: 1 year, \$3.00. Single issue: \$2.00.

Third class postage paid at Richmond, Virginia.

Editorial Advisory Board

John T. Farrar
Ernst G. Huf
Hunter H. McGuire
M. Pinson Neal, Jr.
Kinloch Nelson
Frederick J. Spencer

Editorial Consultants

Larry F. Cavazos *Boston*
Richard G. Lester *Durham*
Sami I. Said *Dallas*
Malcolm E. Turner, Jr. *Birmingham*

Editor

Fairfield Goodale, Jr.

Editorial Assistants

Catherine C. Elverston
Alice C. Reier

Cover Design

Raymond A. Geary

Immunology and the Rheumatic Diseases

Sponsored by the School of Medicine, Department of Continuing Education, and the Division of Connective Tissue Diseases, Medical College of Virginia, Health Sciences Division of Virginia Commonwealth University and by the Virginia Chapter of the Arthritis Foundation

ROBERT IRBY, M.D., *Guest Editor*

Introduction	8
ROBERT IRBY, M.D.	
Modern Immunology: Cells and Molecules	9
FRANKLIN MULLINAX, M.D.	
Recent Advances in Synovial Fluid Analysis	13
DUNCAN S. OWEN, JR., M.D., F.A.C.P.	
Surgery in Rheumatoid Arthritis: General Indications and Philosophic Considerations	18
R. S. BRYAN, M.D.	
Surgical Treatment of the Upper Extremity in Rheumatoid Arthritis	21
CHARLES L. McDOWELL, M.D.	
Surgical Care of the Lower Extremity in Rheumatoid Arthritis	24
ROBY C. THOMPSON, JR., M.D.	
Diagnostic Concordance of Serological Tests for Antiglobulin Antibodies	34
MARION WALLER, PH.D.	
Still's Disease in Adults	38
WILLIAM M. EDWARDS, M.D. STEPHEN R. KOLLER, M.D. MICHAEL J. MILLER, M.D.	
Genetic-Metabolic News	43

INTRODUCTION

The 45th Annual McGuire Lecture Series has been devoted to the subject of Immunology and the Rheumatic Diseases. In this two-day period, 22 outstanding physicians in the field of immunology and rheumatology brought an up-to-date overall concept in the field of rheumatic diseases. Subjects included not only aspects of pathogenesis but also modern laboratory methods in the diagnosis of various connective tissue diseases. The remedial surgical approaches for prevention of pain and disability in rheumatoid arthritis were discussed from a practical viewpoint. This symposium was sponsored in part by the Virginia Chapter of the Arthritis Foundation as well as the Department of Continuing Education at the Medical College of Virginia. Because of the numerous papers submitted, it was decided by the editorial board to devote two issues of the MCV/Q to this series, which will include many of the papers presented at the symposium.

This year our McGuire Lecturer was Morris Ziff, M.D., Ph.D., Professor of Internal Medicine at the University of Texas Southwestern Medical School in Dallas. Dr. Ziff is a world-recognized authority on immunology and connective tissue diseases. He is a past president of the American Rheumatism Association, recipient of the Heberden Medal awarded by the Heberden Society of London, distinguished Alumni Lecturer at the New York University and the first Walter Bauer Lecturer at the Massachusetts General Hospital. As Dr. Toone so aptly remarked in his introduction, "Dr. Ziff has the ability to be firm without rancor, to use quiet humor to establish a point and above all, pre-eminent prestige without a trace element of arrogance." The first lecture which he delivered was entitled "Immunological Aspects of Rheumatoid Arthritis" and the second was "Viruses and the Connective Tissue Diseases."

The latter will be included in the second issue of the MCV/Q along with other papers in the fields of juvenile rheumatoid arthritis, ankylosing spondylitis, infectious arthritis and the more recent aspects of antigenic determinants associated with ankylosing spondylitis, psoriatic spondylitis and Reiter's syndrome.

ROBERT IRBY, M.D.

Professor of Medicine

Department of Medicine

Medical College of Virginia

Virginia Commonwealth University

Modern Immunology: Cells and Molecules* **

FRANKLIN MULLINAX, M. D.

Associate Professor of Medicine, Division of Connective Tissue Diseases, Medical College of Virginia, Health Sciences Division of Virginia Commonwealth University, Richmond

In this presentation I shall discuss 1) some historical highlights in the field of immunology; 2) the molecules of immunity, particularly the immunoglobulins; and 3) the cells of immunity, particularly the immunocytes. This presentation may provide a background for subsequent articles.

Some Historical Highlights (Tables 1 and 2).

From its origins, immunology has been closely associated with infectious diseases, a bias from which we are only now escaping. In the work of early investigators, we can see the clear demonstrations that 1) immunity is important in prevention of disease; 2) there are humoral and cellular phases of the immune response; and 3) immune reactions can themselves produce disease.

Edward Jenner (1749–1823) and Vaccination.

Systematic studies by this quiet scholarly country physician established that inoculation with cowpox pustules produced immunity to smallpox. The practice of inoculation or variolation had existed in the Orient from early times. Material from the vesicle or pustule of an active case of smallpox was inoculated into the skin in order to produce a mild and immunizing attack of smallpox. The value of this method was clearly documented in Benjamin Franklin's pamphlet of 1759, "Some account of the success of inoculation for the smallpox in England and America." Jenner proved that the much more innocent inoculation with cowpox pustules was also successful. During his studies he also discovered that viruses can be attenuated and that an accele-

rated response occurs in previously immunized persons. His was the first account of an allergic reaction in the skin.

Louis Pasteur (1822–1895) and the First Heroic Phase of Immunology. In his thinking, Louis Pasteur was against the temper of his times. Antivitalism was dominant. Liebig and other prominent scientists had no use for the animalcules postulated to explain the origin of disease and fermentation. They were wrong, however, and the germ theory rose again with Pasteur's studies of the souring of milk. His work followed a natural path from studies of crystals to studies of diseases of wine and silkworms, to studies of diseases of man, culminating in immunization and prevention of disease. The studies of chicken cholera revealed that the microbe that kills is the one that immunizes and that the microbe may be attenuated. They suggested to him the possibility of attacking diseases of man. Finally, the renowned studies of rabies led to inoculation of young Joseph Meister on July 6, 1885 with the first and least virulent of his rabies vaccines. Joseph survived the series of injections and became the gatekeeper at the Pasteur Institute.

Pasteur's experiments on immunization were followed by a great outpouring of studies of immunology with concurrent development of biologic and chemical concepts of immunity. On the biological side, Eli Metchnikoff, the wild Russian, migrated to Pasteur's laboratory and championed the non-specific and the cellular aspects of immunity. While looking through his microscope, Metchnikoff saw cells engulfing particles and became the primary discoverer of phagocytosis as a defense mechanism. Koch, also at the Pasteur Institute, showed that whereas the first intradermal injection of tubercle

* Presented by Dr. Mullinax at the 45th Annual McGuire Lecture Series, November 8, 1973, at the Medical College of Virginia, Richmond.

** This is publication No. 67 from the Charles W. Thomas Arthritis Fund.

TABLE 1

IMMUNOBIOLOGY

May 14, 1796	Edward Jenner established vaccination.
July 6, 1885	Louis Pasteur injected attenuated rabies virus into Joseph Meister.
1882	Eli Metchnikoff and phagocytosis.
To 1905	Bordet, Arthus, von Pirquet, Schick, Ehrlich.
1953	Owen, Medawar and Burnet. Immunologic tolerance.

bacilli evoked no response in guinea pigs, the second injection led to an inflammatory reaction, thus initiating the concept of delayed hypersensitivity or cellular immunity.

The Pasteur Institute was also involved in chemical studies of immunity. After Pasteur's work on bacteria as the cause of diseases of wine, beer, and later, of man, attention turned to diphtheria. Roux expected that this devastating disease would be characterized by massive bacterial proliferation; but only a few bacilli could be isolated from the local lesion. Something else must be responsible for the toxicity of diphtheria. This line of investigation led to the isolation of bacterial toxins, the preparation of antitoxins, identification of the antitoxins as serum

TABLE 2

IMMUNOCHEMISTRY

October 30, 1845	William MacIntyre examined the urine of his patient, Mr. Macbee, who had myelomatosis.
1890	Roux and Behring identified toxins and antitoxins.
1900	Landsteiner described blood group antigens and antibodies.
1920	Beginnings of quantitative immunochimistry with Heidelberger, and later, Kabat and Marrack.
1948	Hargraves described the LE cell.
1960's	Fundamental discoveries of antibody structure: Putnam, Porter, Edelman, Hood, Dreyer.

proteins, prophylactic use of antitoxin-containing sera, and description of serum sickness. This phase of research extended through 1905 with the publication of *Serum Sickness* by von Pirquet and Schick. Forgetting many other important contributions, we may turn to 1953 and the development by Owen, Medawar, and Burnet of the concept of immunologic tolerance, another landmark in the biology of immunity.

The Chemistry of Immunity. On October 30, 1845 a practicing physician, William MacIntyre, examined the urine of his patient, Mr. Macbee, who had the disease now known as multiple myeloma. The peculiar reactivity of his urine—a precipitate formed on warming and dissolved with boiling—led Dr. MacIntyre to consult with Dr. Henry Bence Jones. More than a hundred years later, studies of the Bence Jones proteins ushered in a second heroic phase of immunology. Bence Jones proteins and serum monoclonal proteins have proved to be a Rosetta stone of immunology.

In 1900 Karl Landsteiner discovered blood group antigens and their corresponding antibodies. His chemical studies, particularly with low molecular weight haptens, set the stage for quantitative immunochimistry, developed by Heidelberger and Kabat, and by Marrack, from the 1920's through the 1950's. The discovery of the LE cell by Hargraves in 1948 was important because it led to detailed studies of the chemical basis of apparent autoimmune reactions. Early in the 1960's the work of Edelman, Porter, Putnam, and others gave the central focus of immunology on the now familiar four-chain structure of an antibody monomer.

The Immunoglobulins. It is fortunate that the simple technique of paper or cellulose acetate electrophoresis provides a rather complete separation

TABLE 3

THE IMMUNOGLOBULINS

IgG—The main antibody class.
IgA—Antibody, especially in secretions.
IgM—Macroglobulins.
IgD—?
IgE—Skin sensitizing antibody.

of the antibodies. Most antibodies are in the γ -globulin fraction and most γ -globulins are antibodies. More sophisticated techniques, particularly immunoelectrophoresis, reveal that some antibodies are in other electrophoretic fractions and that there are at least five classes of antibodies. These are the immunoglobulins: IgG, IgA, IgM, IgD, and IgE (Table 3). IgG is the main circulating immunoglobulin; IgA is prominent in secretions (tears, saliva); IgM is generally a pentameric molecule, restricted to the intravascular space and particularly effective biologically; IgD is a minor component of uncertain function; and IgE is present in trace amounts but is extremely important because it mediates immediate (anaphylactic) hypersensitivity.

A diagrammatic representation (Fig. 1) of the IgG molecule reveals that it has four chains—two light chains and two heavy chains. The light chains (Bence Jones proteins) are often produced in excess by plasma cells. Large amounts of these proteins are excreted by many patients with myelomatosis. Variations in amino acid sequences in the first part of the light and heavy chains provide variations in antibody specificity, that is, antibody diversity. Further structural studies reveal that the light chains have two and the heavy chains have four disulfide domains, homologous parts of the molecule which rotate almost independently. Another way to examine the molecule is literally by looking at it. High-resolution electron micrographs reveal the IgG molecules to be Y-shaped with the two antigen binding sites on the forks. IgM molecules have five monomer Y's around a central core.

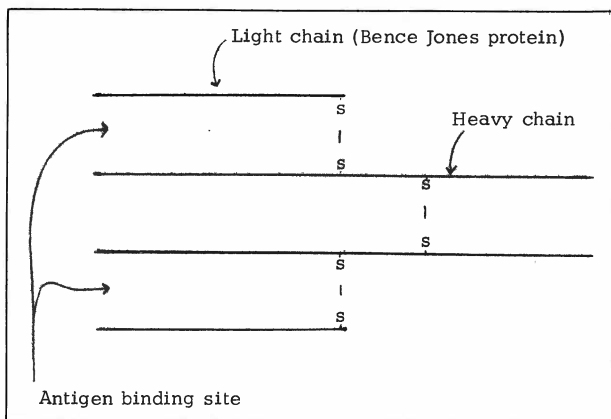

Fig. 1—Diagrammatic representation of an IgG molecule.



Fig. 2—Electron micrograph of a plasma cell from a human kidney graft removed because of impending rejection. Note the prominent endoplasmic reticulum. (Courtesy of Dr. W. J. S. Still, Medical College of Virginia).

These immunoglobulins are the mediators of humoral immunity and are produced by cells of the plasma cell series. These secretory cells (Fig. 2) have an elaborate endoplasmic reticulum which contains the organelles concerned with synthesis and secretion of plasma proteins.

Cellular Immunity. A different group of cells, activated lymphocytes, mediate cellular immune reactions. Such an activated lymphocyte is seen in figure 3. Upon antigenic stimulation, lymphocytes mediating cellular immune reactions enlarge, divide, and provide mediators, lymphokines, which incite local inflammatory reactions. Cellular immunity is largely responsible for immunity against intracellular parasites, contact drug allergy, graft rejection, and tumor rejection. A typical reaction of cellular immunity is the reaction of delayed hypersensitivity, such as the tuberculin reaction.

Observations on patients with immunodeficiency

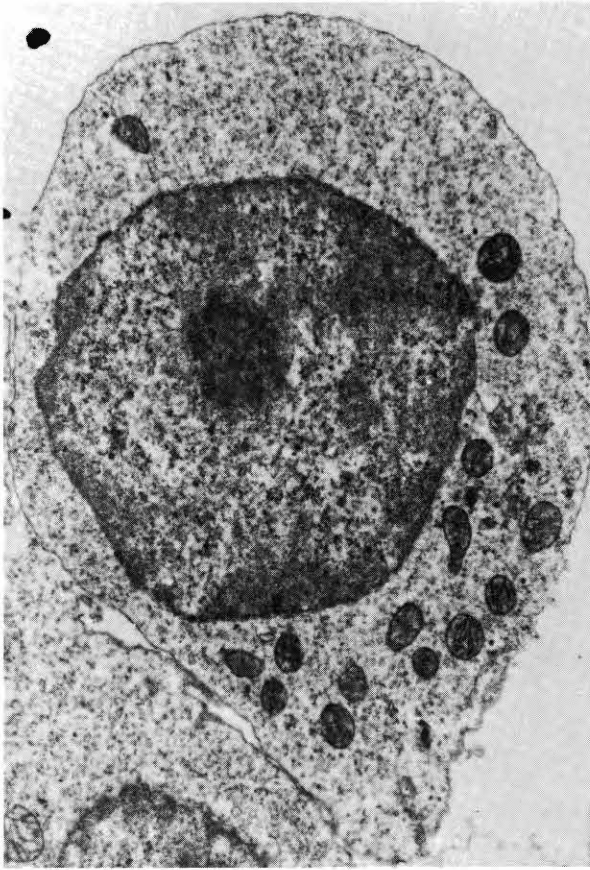

Fig. 3—Electron micrograph of a transformed lymphocyte in the splenic white pulp of a lethally x-irradiated mouse 36 hours after injection of rat small lymphocytes. Note the absence of endoplasmic reticulum. This rat lymphocyte became transformed after contact with immunologically foreign mouse tissue. It is now prepared to provide a line of cells mediating the graft-versus-host response. (Courtesy of Dr. J. L. Gowans, Oxford University, and publishers, S. Karger, Basel/New York).¹

diseases and experiments in animals have given rise to the concept of two different systems that mediate humoral and cellular immunity (Fig. 4). According to this view, stem cells from the bone marrow migrate to breeding sites for the cells of the two types of immunity. In the chicken, plasma

cell precursors (B cells) are produced in the bursa of Fabricius, an organ near the cloaca. In man, the corresponding tissues are not clearly identified. The marrow itself or gut-associated lymphoid tissue may be involved. The second breeder site is the thymus. It provides T lymphocytes and cellular immunity. Interrelations of T and B cells are complicated and important, as some of the following presentations will indicate.

In this brief overview, I have presented some historical highlights of chemical and biologic approaches to immunology. The chemical approaches lead to our current detailed picture of immunoglobulin structure. The biologic studies lead to the concept of a two-component system, B and T cells, mediating humoral and cellular immunity. These chemical and biologic findings provide a framework for analyzing not only basic immunology but also clinical diseases. For completion, I should briefly mention the scavenger macrophages—probably important in antigen processing; the complement system—important in amplifying the effects of an immune response; the kinins and other molecules of inflammation; and the polymorphonuclear leukocytes and other apparently nonspecific defenders.

The Immunologic Mosaic. The outlines of modern immunology are now discernible. The resultant picture is like a mosaic rather than a photograph. We are now at the exciting point where the form is emerging.

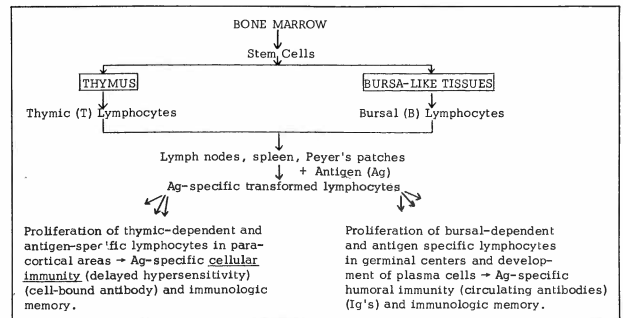

Fig. 4—Bone marrow - thymus - bursa interrelations. The bursa-like tissues in man may be either the bone marrow itself or certain gut-associated lymphoid tissues (GALT).

¹ Reprinted by permission from Gowans JL, McGregor DD: The immunological activities of lymphocytes. *Progress in Allergy* 9:1, 1965.

Recent Advances in Synovial Fluid Analysis*

DUNCAN S. OWEN, JR., M. D., F. A. C. P.

Associate Professor of Medicine, Division of Connective Tissue Diseases, Medical College of Virginia, Health Sciences Division of Virginia Commonwealth University, Richmond

Synovial fluid analysis is a frequently ignored examination except in suspected cases of septic conditions. It has been shown that it is an extremely valuable procedure in making rapid and accurate diagnoses in many types of joint diseases.

Table 1 illustrates the findings in ten separate joint states. The gross appearance, "wet-prep" microscopic examination, leukocyte count and sugar content are procedures that are extremely important and can be performed with a paucity of equipment. We have not found the mucin-clot test or protein content to be very helpful. Of course, if infection is a possibility, Gram's stain and appropriate cultures should be instituted. It should be remembered, however, that only 25–30% of the cases of gonococcal arthritis will be associated with a positive Gram's stain or culture. The culture yield may possibly improve with the increasing use of Thayer-Martin media. The anticoagulant should be either heparin or EDTA instead of oxalate because the examiner may confuse oxalate crystals with urate or pyrophosphate crystals.

Cell Counting. The white blood cell count is of particular importance in suspected septic conditions. Methods have been outlined in detail in an excellent book by Ropes and Bauer. The fluid should be collected in an anticoagulant tube. The diluent should be physiologic saline because acetic acid will cause precipitation of mucin and make an accurate count practically impossible. The addition of methylene blue to the diluent will help differentiate the cell types. If the fluid is hemorrhagic, a hypo-

tonic diluent of 0.3% sodium chloride can be tried which theoretically will disrupt the red blood cells but not the nucleated cells.

A differential white count using Wright's stain is performed in the same manner as a peripheral blood smear. If the total white blood count in the synovial fluid is less than 5,000/mm³, it is best to centrifuge the fluid at 2,000–3,000 rpm for ten minutes. The supernatant is then removed and physiologic saline added to the sediment until the original volume is obtained. The solution should then be recentrifuged which will remove most of the mucin. The sediment can then be easily smeared on a slide, air dried, and stained. In cases of systemic lupus erythematosus (SLE), the LE cell may be seen.

Glucose. The glucose value of normal synovial fluid usually parallels that of serum. The results are of greater value if the patient has been fasting for about six hours. It is even possible for normal synovial fluid sugar to be higher than that of the serum for several hours postprandially.

In any suspected septic joint condition, a glucose determination should always be performed. We have found the glucose levels to be low in almost all cases of septic arthritis observed at the Medical College of Virginia during the past seven years. It is important to have the glucose level determined immediately after aspiration. Because of the glycolytic action of white cells, falsely low levels may be observed in cases of rheumatoid arthritis and gout, for example, if the white cell count of the fluid is high and the fluid is not tested for one or more hours. The falsely low sugar level can also be prevented by placing the fluid to be tested in a sodium fluoride tube. A synovial glucose of 50 mg %

* Presented by Dr. Owen at the 45th Annual McGuire Lecture Series, November 8, 1973, at the Medical College of Virginia, Richmond.

TABLE 1
SYNOVIAL ANALYSIS

Disease	Appearance	Mucin Clot	Viscosity	Leukocytes per mm ³	Sugar: serum-synovial difference (mg/100ml)	Crystals	Comment
Normal	Clear, amber	Good	High	<200 <25% polys	<10	None	
Gouty Arthritis	Milky or yellow	Poor	Low	15,000+ 70% polys	10±	Sodium urate	Strongly negative birefringent intra- and extracellular urate crystals.
Pseudogout	Turbid, amber, or yellow	Fair to Poor	Fair or Low	25,000± 90% polys±	10±	Calcium pyrophosphate	Few-to-many weakly positive intra- and extracellular calcium pyrophosphate crystals.
Rheumatoid Arthritis	Turbid, amber to light green	Poor	Low	15,000+ 70% polys	25	Occasional cholesterol	WBC inclusions frequently present. Rheumatoid factor usually present.
Septic Arthritis	Very turbid, gray	Poor	Low	70,000± 90% + polys	70	None	Culture positive in only 20-30% of GC cases.
Tuberculous Arthritis	Turbid, amber, or yellow	Poor	Low	30,000± 60%± polys	50+	None	Biopsy frequently helpful.
Osteoarthritis	Clear, amber	Good	High	1000± 10% polys	<10	None	Cartilage fibrils may be present.
Acute Traumatic Arthritis	Bloody or turbid	Good	High	<2000 <25% polys	<10	None	Occasional cartilage fibril. Many RBC's.
Systemic Lupus Erythematosus	Slightly turbid, amber	Good	High	3000± <10% polys	10±	None	Examine for LE cells.
Rheumatic Fever	Slightly turbid, amber	Good	Fair to Low	15,000 50% polys	10±	None	Occasional WBC inclusion

less than fasting serum should be considered as strongly indicating an infectious process until proved otherwise.

"Wet Drop" Preparation Studies. The microscopic examination of a drop of fresh or anticoagulated synovial fluid may yield diagnostic information, especially in cases of crystal deposition diseases (gout and pseudogout). This examination is performed by placing a small drop of synovial fluid on a glass slide, covering with a cover slip and sealing the edges with clear fingernail polish. Only a small drop is used to prevent individual cells from

moving across the field of view. Sealing the slide prevents the formation of artifacts while drying and will preserve the specimen for one or more hours.

The synovial fluid findings in the crystal deposition diseases, gout (monosodium urate crystal deposition disease) and pseudogout (calcium pyrophosphate dihydrate crystal deposition disease), were described in the early 1960's. The discovery and identification of these crystals in synovial fluid, using the compensated polarizing microscope, led to great enthusiasm in making rapid and accurate diagnoses of crystal-induced synovitis. Unfortunately,

the compensated polarizing microscope is an expensive piece of equipment, which is not readily available in the office of most physicians and it is infrequently found in general hospitals.

Simple Polarization. A simple polarizing microscope can be made from an ordinary microscope by inserting a polarizing filter below the condenser, usually on top of the light source (the polarizer), and using one filter above the objective, usually in the barrel or above the eye piece (the analyzer). The polarizer is then rotated until the darkest field possible is obtained. The monosodium urate (MSU) crystals usually appear as bright needles against this black background. The calcium pyrophosphate dihydrate (CPPD) crystals usually appear in bright monoclinic, triclinic, rectangular or rhomboid forms, and may be quite difficult to differentiate from MSU crystals in synovial fluid. Figure 1 illustrates the placement of simple plastic polarizing filters in a laboratory microscope.

Compensated Polarization. The compensated polarizing microscope utilizes a first-order red filter, the compensator, which is inserted between the objective and the analyzer. The compensator retards red light and the polarized background becomes red instead of black. The axis of the line of slow vibration of the compensator is then defined. The MSU and CPPD crystals will be either yellow or blue, depending upon their respective positions to this axis. The MSU crystal is brightly yellow when parallel to the axis and indicates that it is strongly negatively birefringent. The CPPD crystal is faintly blue when in this position, indicating weakly positive birefringence.

On occasion, both MSU and CPPD crystals are noted in the same fluid indicating coexisting disease. Previously injected adrenocorticosteroids, oxalate anticoagulant, cholesterol crystals, and scratches on the slide or coverslip should not be confused with either MSU or CPPD crystals.

New and Simple Technique. We have found a very adequate substitute for the first-order red filter which can be used with an ordinary light microscope which has been adapted with simple polarizing filters. One needs only a clean microscopic glass slide and simple transparent cellophane tape. One piece of the cellophane tape is carefully applied to the top side of the slide and then another piece of tape is applied over this. Wide tape is preferable but two pieces of narrow tape carefully applied

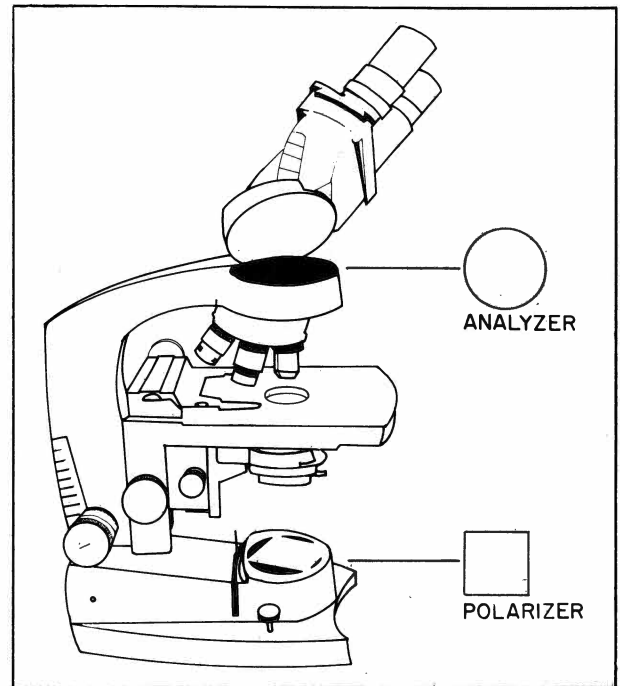

Fig. 1—Illustration of simple plastic polarizing filters in barrel of microscope (analyzer) and above light source (polarizer).

beside two other pieces is satisfactory. The microscope is then adapted for simple polarizing microscopy as previously described. (One may first wish to focus on the material to be examined.) The cellophane-taped slide is then placed over the polarizer and carefully rotated until the background is quite red. We have discovered that the long axis of the taped slide substitutes amazingly well for the axis of slow vibration of the first-order red compensator. The examiner can then mentally project the axis of the taped slide on the stage. Figure 2 illustrates the cellophane-taped slide on top of the polarizer. With the stage arranged to permit free movement of the "wet-prep" slide, the examiner can then rotate the "wet-prep" slide and define whether the observed crystals are negatively or positively birefringent.

It should be emphasized that cellophane is closely controlled for thickness in its manufacturing process but not for its refractive index. Therefore, there may be a different retardation with each supply of cellophane tape. We have tested numerous batches of cellophane tape. Approximately 50% will give the red background and the other 50%

a blue background. The interested examiner may have to purchase a few rolls of tape until a satisfactory one is found.

The improvised compensated polarizing microscope techniques described above have been a tremendous help in making a rapid and accurate diagnosis of crystal-induced synovitis. Faculty, housestaff, and students are encouraged to carry polarizing filters and a cellophane-taped microscope slide with them. A great deal of enthusiasm has been expressed. For the first time, individuals are really learning the true meaning of the planes of birefringence. In the past, many individuals memorized, in preparation for written examination, which crystals were negatively or positively birefringent. It is hoped that others will discover these techniques to be helpful to them. Examiners will be greatly helped in establishing their own personal techniques by smearing some MSU crystals from a tophus on a clean microscopic slide. They can then experiment with the filters until the simple maneuvers are mastered.

Ragocytes (RA cells, inclusion body cells, raisin seed cells) in synovial fluid of patients with rheumatoid arthritis were originally described by Dr. Joseph Hollander and associates. These cells

are leukocytes containing inclusion bodies. They appear as dark granules under regular light microscopy at high dry magnification and as clear vacuolated areas with phase microscopy. It was assumed that these bodies were phagocytosed rheumatoid factor and they were noted in from 5–95% of the total leukocyte population of rheumatoid synovial fluid. It was believed that phagocytosis of rheumatoid factor played a role in the pathogenesis of rheumatoid arthritis in a similar fashion to the phagocytosis of sodium urate crystals in the pathogenesis of gouty arthritis. This concept was supported with the production of acute synovitis by the injection of autologous γ G-globulin into inactive joints of patients with rheumatoid arthritis. Subsequent studies have shown that the findings of these leukocyte inclusions are not specific for rheumatoid arthritis. They may be found in other types of inflammatory joint disease and may be scavengers which have phagocytosed products of inflammation including γ -globulins.

Osteoarthritis fluid may reveal a few-to-many cartilage fibrils and fragments. These may also be seen in cases of pseudogout.

Cholesterol crystals are noted rarely in the fluid of cases of chronic rheumatoid arthritis. These crystals are large, rhomboid, have punched-out corners and are birefringent.

An inexperienced examiner may confuse previously injected corticosteroid ester crystals with urate or pyrophosphate crystals. The steroid crystals may be phagocytosed by white cells and apparently can precipitate a "postinjection flare" of the injected joint. The crystals are usually negatively birefringent.

Reiter's syndrome synovial fluid has been reported to show large mononuclear cells containing many vacuoles. Some of these cells appear to contain polymorphonuclear cells. The specificity of this is unclear.

Table 2 illustrates the complement (C') levels in various disease entities. It is most helpful, however, to know the normal values and type of complement determination for each laboratory. For example, if total complement is determined on a viscous synovial fluid and if a diffusion technique is used, poor diffusion may occur due to viscosity and erroneously low level results.

Summary and Conclusions. Examination of synovial fluid is a most helpful test for making a

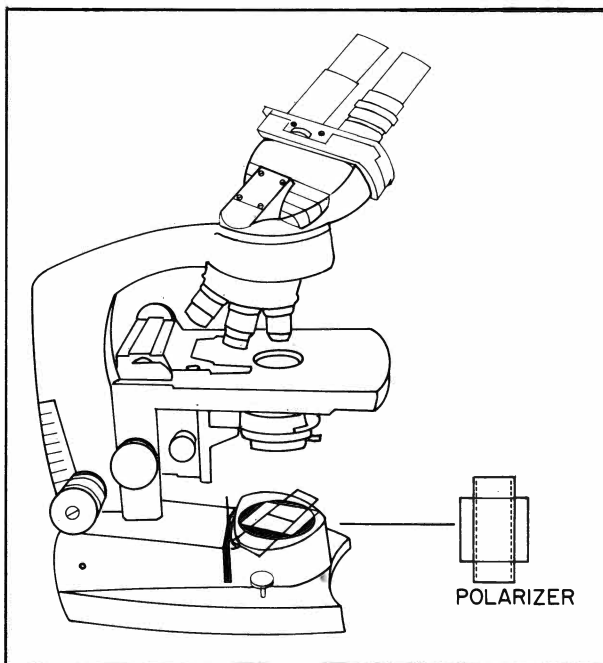

Fig. 2—Illustration of "cellophane tape compensator" above the polarizer.

TABLE 2
COMPLEMENT

	Serum	Synovial Fluid
Rheumatoid arthritis	N (rarely ↓)	↓
Systemic lupus erythematosus	↓	↓
Reiter's	N	↑↑
Septic	N (occ. ↑)	↑
Crystal disease	N	N or ↑
Spondylitis & psoriasis	N	N or ↑

definitive diagnosis of one of the various types of arthritis, especially gout, pseudogout and septic arthritis. Unfortunately, it is one of the most frequently ignored tests. It should be remembered that only a few drops of fluid are needed for a "wet drop" examination for crystals, ragocytes, Gram's stain and a Wright's stain.

BIBLIOGRAPHY

- COHEN AS** (ed): *Laboratory diagnostic procedures in the rheumatic diseases*. Boston, Little, Brown & Co., 1967.
- HOLLANDER JL, McCARTY DJ Jr, ASTROGA G, CASTRO-MURILLO E**: Studies on the pathogenesis of rheumatoid joint inflammation. I. The RA cell and a working hypothesis. *Ann Intern Med* 62:271, 1965.
- HOLLANDER JL, REGINATO A, TORRALBA TP**: Examination of synovial fluid as a diagnostic aid in arthritis. *Med Clin North Am* 50:1281, 1966.
- KAHN CB, HOLLANDER JL, SCHUMACHER HR**: Corticosteroid crystals in synovial fluid. *JAMA* 211:807, 1970.
- McCARTY DJ Jr**: A basic guide to arthrocentesis. *Hosp Med* 4:77, 1968.
- McCARTY DJ Jr**: On the crystal deposition diseases. *Disease-a-Month*, pp 1-31, March, 1970.
- McCARTY DJ Jr, HOLLANDER JL**: Identification of urate crystals in gouty synovial fluid. *Ann Intern Med* 54:452, 1960.
- McCARTY DJ Jr, KOHN NN, FAIRES JS**: The significance of calcium phosphate crystals in the synovial fluid of arthritic patients. The "pseudogout syndrome." I. Clinical aspects. *Ann Intern Med* 56:711, 1962.
- MOSKOWITZ RW, KATZ D**: Chondrocalcinosis and chondrocalcinosis (pseudogout syndrome). *Am J Med* 43:322, 1967.
- OWEN DS Jr, COOKE CL, TOONE E**: Practical synovial fluid examination. *Va Med Month* 97:88, 1970.
- PEKIN JJ, MALININ IL, ZVAIFLER NJ**: Unusual synovial fluid findings in Reiter's syndrome. *Ann Intern Med* 66:677, 1967.
- PHELPS P, STEELE AD, McCARTY DJ Jr**: Compensated polarized light microscopy. Identification of crystals in synovial fluids from gout and pseudogout. *JAMA* 203:508, 1968.
- ROPES MW, BAUER W**: *Synovial fluid changes in joint disease*. Cambridge, Harvard University Press, 1953.
- SCHUMACHER HR**: Intracellular crystals in synovial fluid anticoagulated with oxalate. *N Engl J Med* 274:1372, 1966.
- SKINNER M, COHEN AS**: Calcium pyrophosphate dihydrate crystal deposition disease. *Arch Intern Med* 123:636, 1969.
- VAUGHAN JH, BARNETT EV, SOBEL MV, JACOX RF**: Intracytoplasmic inclusions of immunoglobulins in rheumatoid arthritis and other diseases. *Arth Rheum* 11:125, 1968.
- VAUGHAN JH, JACOX RF, NOELL P**: Relationship of intracytoplasmic inclusions in joint fluid leukocytes to anti- γ G-globulins. *Arth Rheum* 11:135, 1968.
- ZUCKNER J, UDDIN J, GANTNER GE, DORNER RW**: Cholesterol crystals in synovial fluid. *Ann Intern Med* 60:436, 1964.
- ZUCKER-FRANKLIN D**: The phagosomes in rheumatoid synovial fluid leukocytes: A light, fluorescence and electron microscopic study. *Arth Rheum* 9:24, 1966.

Surgery in Rheumatoid Arthritis: General Indications and Philosophic Considerations*

R. S. BRYAN, M. D.

*Assistant Professor, Orthopedic Surgery, Mayo Medical School,
University of Minnesota; Consultant, Mayo Clinic, Rochester*

An orthopedic surgeon once referred to general surgeons as "residual surgeons"; and in rheumatoid arthritis, orthopedic surgeons might be referred to as surgeons of the residuum because we are called only after all of the medical treatments. We would like to be called earlier because we do have something to offer many patients.

One of the dramatic developments of recent years in rheumatoid arthritis is the rehabilitation potential that is realized in total joint replacement. It is miraculous when a patient who has become bedfast despite good medical management is rendered ambulatory within six weeks by the replacement of two or three lower extremity joints. This is not possible, however, in every patient; and the abyss of total disaster and even death lurks behind every improperly chosen and orchestrated surgical sequence.

Successful results of surgery in the arthritic depend as much on a wise choice of patient and operation as on the skillful performance of the surgery. The most important consideration in choosing the patient is that he or she is willing to have the operation. Operating on unwilling patients often leads to lawsuits and generally gives rise to discomfort for both patient and surgeon. Willing, however, means not only that the patient is willing to have surgery, but also that the patient understands realistically what you are attempting to achieve

and is willing to cooperate fully in order to attain the desired result.

Motivation is slightly different but is ancillary; the *patient* must want to have the operation, not the relatives. If the relatives push the patient into the room and say, "Mother wants to have her knees operated on," beware. That patient may be perfectly happy to sit in a wheelchair and may be bitterly resentful after surgery. I mistakenly operated on such a patient, replacing both knee joints and stretching out contractures of 60 degrees. After she went home, she took off her braces and allowed the contractures to recur because "it was too much bother to wear them." I achieved nothing because I chose the wrong patient for surgery.

The second facet of motivation is the willingness to continue good medical management. One of my patients had been taking the "Mexican pill" and was Cushingoid with destroyed knee joints and osteoporotic bones. We replaced both knee joints and reduced her steroid doses to a reasonable level. She returned after one year with her knees doing well but had resumed large doses of steroids because the other joints limited her activities. We achieved nothing in that patient since our treatment merely permitted her to abuse other joints, and we were unable to make her understand and accept her disease and its proper management.

There must exist in the properly chosen patient a need for surgery. If there is a mechanical method that will suffice by means other than surgery, such as injection, splinting, or physical therapy, that method should be chosen.

* Presented by Dr. Bryan at the 45th Annual McGuire Lecture Series, November 8, 1973, at the Medical College of Virginia, Richmond.



Fig. 1—This is a 55-year-old man with rheumatoid arthritis. Note the destruction of bone from the arthritis.

There are also certain basic requirements in the form of muscles, ligaments, and bone structure that pertain to each surgical procedure and vary from joint to joint. In a Walldius total knee arthroplasty, for example, you must have a good quadriceps but do not need ligaments, while in other types



Fig. 2—Photograph taken at surgery showing the prostheses in place. The high density polyethylene bushing is seen separating the metal portions of the hinge.

of knee replacement, ligament stability is more important.

In rheumatoid arthritis, initially, synovitis occurs with little mechanical damage to the joints; but as the disease progresses, structural changes



Fig. 3 A, B—The x-rays show that the axis of the hinge is in line with the anterior surface of the humerus in the correct position.



Fig. 4 A, B—These two photographs show the range of motion achieved at three weeks after surgery.

occur that would cause progressive deterioration, even if the arthritis were miraculously cured. Synovectomy at that late stage accomplishes little. The difficulty is in knowing when the mechanical damage is severe enough to preclude synovectomy. Certainly, when erosion and surface irregularities appear, it is more reasonable to suggest arthroplasty. When still more destruction has occurred and gross instability ensues, the choice evolves to a hinged or unhinged total knee arthroplasty or arthrodesis. At each stage in the disease—just as in the medical management, the least lethal medication possible is used—in surgery, the least lethal operation is chosen.

One of the bold new experiments involves the replacement of the elbow joint. Figure 1 shows a roentgenogram of a rheumatoid elbow with severe

destruction, somewhat resembling the old fascial arthroplasties. Figures 2 and 3 show the Coonrad hinge. This has a polyethylene bushing through which the cross pin connects the two parts of the hinge. The stems are cemented to the bone in the humerus and ulna. The pin rotates and so do the bushings, giving a wide weight bearing area. Figure 4 shows the patient three weeks after surgery demonstrating his range of motion.

In summary, orthopedic surgery has much to offer the rheumatoid patient, particularly if the proper patient is chosen at the proper time. The advent of the total joint replacements, now in its infancy, gives renewed hope for the salvage of many derelicts and for the prevention of the severe disabilities and deformities which were all too frequent in the past.

Surgical Treatment of the Upper Extremity in Rheumatoid Arthritis*

CHARLES L. McDOWELL, M. D.

Assistant Clinical Professor, Orthopedic Surgery, Medical College of Virginia, Health Sciences Division of Virginia Commonwealth University, Richmond

All surgical procedures designed to preserve or improve function in the extremities, whether in rheumatoid arthritis or not, must consider the functional emphasis of the upper extremity as compared to the lower extremity. The upper extremity has, as its primary goal, mobility and prehension, whereas in the lower extremity, stability is the most important goal, mobility the next in order of importance, and prehension the least important. For example, the feet fulfill a need for stability with very little requirement for prehension, but the hand is more an instrument for prehension and there is less need to consider stability.

I have divided surgery in the upper extremity of the rheumatoid patient into the surgery of prevention and the surgery of repair—that is, those procedures designed to *prevent* the loss of function and those designed to *restore* some measure of function.

Surgery of Prevention. *Synovectomy.* One might include synovectomy under the surgery of prevention. The question of whether synovectomy is worthwhile as a possible means of controlling the progression of rheumatoid disease in any particular joint is not appropriate to this discussion. My personal view is that synovectomy alone has not adequately been shown to favorably alter the course of rheumatoid arthritis in the involved joint, although there is definitely a place for synovectomy

whenever synovial tissue itself interferes with function or when it is causing intractable pain. Further, synovectomy done in association with certain anatomic adjustments is an essential element in the operative procedure. An example of such a situation is illustrated by the patient who has monarticular synovitis of a metacarpal phalangeal joint with severe pain and limitation of motion and who has not responded to the usual conservative methods applied over a reasonable period of time. In such an instance there is a reasonable chance of attaining at least some pain relief if not some improvement in the range of motion of that joint.

Anatomic Adjustments. These are procedures which are often done in association with synovectomy to prevent further progression of destructive processes that we know will cause a functional loss to the patient if some surgical adjustment is not made. Radial-head excision, along with synovectomy of the elbow joint, may preserve pronation and supination at the elbow and perhaps even flexion and extension at the elbow longer than it would have been preserved using conservative treatment alone. The procedure is also helpful in relieving pain. Radial-head excision is ordinarily not considered as a possibility until there is x-ray evidence of advanced destructive changes and clinical evidence of persistent pain and reduction in the range of motion.

When the patient has tenosynovitis on the extensor surface of his wrist and hand, there is a threat of possible destruction of extensor tendons with consequent severe loss of function. A synovec-

* Presented by Dr. McDowell at the 45th Annual McGuire Lecture Series, November 8, 1973, at the Medical College of Virginia, Richmond.

tomy is in order because the synovial tissue seems to cause destruction of the tendons by ingrowth into the substance of the tendon; indirectly, there is damage by competition with the blood supply and also by compression underneath the extensor retinaculum which also interferes with the blood supply. At the same time that the synovectomy is done, the extensor retinaculum is removed, so that if synovitis recurs the tendons will not be exposed to compression and consequent loss of blood supply. Usually the retinaculum itself is preserved but re-routed beneath the extensor tendons and sutured down to the capsule of the wrist joint. This collagen graft helps to stabilize the wrist joint itself, so that a tissue which was in a potentially destructive position before surgery is converted to an assistant which may help to stabilize the wrist joint.

When synovitis in the flexor canal, which contains the long flexor tendons and the median nerve, increases the pressure within the volar canal, the patient experiences decreased function of the median nerve distal to the wrist. There are signs and symptoms of carpal tunnel syndrome. If this condition is allowed to progress the patient may ultimately develop a complete nonfunction of the median nerve and the flexor tendons may rupture; the mechanism would be the same as that described for extensor tendons under the extensor retinaculum. Therefore, a release of the volar carpal ligament combined with synovectomy will preserve irreplaceable function of the median nerve and probably prevent rupture of the flexor tendons.

Frequently, synovitis occurs in the flexor tendon sheaths in the finger. When it progresses to the point where the flexor tendons are unable to glide through the pulleys, a situation described as "trigger finger" exists. This painful locking of the flexor tendons cannot be treated by a simple division of the pulleys because severe functional loss is a consequence of division of the pulleys. In this instance a complete synovectomy of the flexor tendons in the fingers will allow them to become flexible again.

The Surgery of Repair. *Repair or Grafting of Ruptured Tendons.* As pointed out earlier, the surgery of repair is indicated when anatomic equipment has already been destroyed by the rheumatoid process and some kind of reconstruction or substitution should be considered. Some examples include the repair or grafting of ruptured tendons. Rupture of tendons can occur on the extensor surface of the

wrist or in the flexor canal or in the digits as a result of synovitis as described earlier. Another frequent cause of tendon rupture is dorsal dislocation of the head of the ulna with sharp bone edges which physically abrade the extensor tendons. The repair is accomplished by placing a tendon graft between the muscle and the distal stump of the tendon and by removal of the distal ulna. Other substitution procedures include such things as tendon transfers to replace ruptured tendons or to replace a specific function when there is an imbalance problem caused by contractures or tendon rupture.

Release of "Stuck" Tendons. Another example of surgery of repair is seen in patients who have ignored the destructive process or were unaware of the destructive process to the point where the tendons have stuck together or to surrounding tissues. Consequently, tendon gliding is prevented and there is no function in the digit. A reconstruction here requires removal of adhesions to allow the tendons to glide once again.

Arthrodesis of Small Joints. The small joints in the hand are exposed to the ravages of rheumatoid arthritis and osteoarthritis follows directly in its footsteps resulting in severe pain and instability. Fortunately, some joints do not require motion to be useful; therefore, an arthrodesis of some small joints which relieves pain and provides stability can be a definitive and helpful operation. Arthrodesis of the thumb metacarpal phalangeal joint and arthrodesis of the wrist are the most commonly performed fusions in patients with rheumatoid arthritis.

Selective Excision of Rheumatoid Nodules. We are all aware of the fact that rheumatoid nodules have a high recurrence rate after excision; however, nodules may appear in areas where they can cause much pain and interfere with function of a hand out of proportion to their usually benign nature and surgical excision is indicated.

Resection Arthroplasty of Small Joints. In the last thirty years or more, surgeons have been attempting to provide motion and a reduction in pain in the small joints of the hand by performing an arthroplasty where arthrodesis was not a reasonable alternative. We attempted to produce a type of pseudojoint by removing a portion of the old destroyed joint and substituting some type of soft tissue, such as fascia or tendon, for articular cartilage. Such soft tissue arthroplasties have helped to reduce pain in the involved joints and have helped

to increase the range of motion in the involved joints; however, the soft tissue arthroplasties have fallen far short of normal function. The soft tissue arthroplasties do not hold up over a long period of time because the interposed soft tissue tends to disappear with time allowing the bone ends to come back together and pain is a result.

Replacement Arthroplasty of Small Joints.

Presently, soft tissue arthroplasties are being augmented by the use of a spacer between the two bone ends to prevent the two bone ends from migrating back together. The spacers which are inserted also have a certain amount of inherent rigidity which improves the stabilizing characteristics of the arthroplasty. We are using Silastic® spacers or prostheses of which there are now three popular types: Swanson, Niebauer, and Calnan-Nickel (the Swanson type is illustrated). Experience has shown that the implant type of arthroplasty can greatly improve the average range of motion following surgery and can also maintain pain reduction for many years. Stability is improved over the pure soft tissue arthroplasty but is not as good as normal. Recurrence of ulnar drift is still a significant problem in this type of arthroplasty.

Another type of arthroplasty which is moving us closer to the theoretical optimum of total joint replacement is the Steffey; it is a metal prosthesis with two sections. Each section has a stem, which is inserted into the respective medullary canal, and a high density polyethylene articulating surface. The two pieces are snap-fitted together and the stems are held in place with methylmethacrylate bone cement. This prosthesis is a direct outgrowth of the earlier metal prosthesis designed by Brannon and

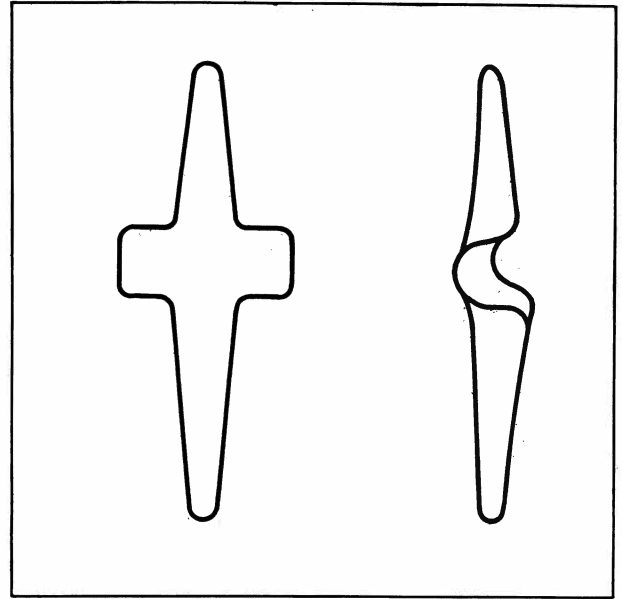

Fig. 1—Silastic® finger joint prosthesis of the Swanson design.

another designed later by Flatt. One of the most important hopes that we have for this prosthesis is that it will provide a higher degree of stability. At the present time, this particular prosthesis is not widely available.

In closing, I should like to emphasize a point that Dr. Bryan has made. It is wise for all of us to appreciate the fact that the surgeon always loses his battle to rheumatoid arthritis. The best the surgeon can possibly hope to do is to ameliorate the symptoms or preserve or sometimes even to reconstruct lost functional parts.

Surgical Care of the Lower Extremity in Rheumatoid Arthritis*

ROBY C. THOMPSON, JR., M. D.

Professor of Orthopedic Surgery, University of Virginia School of Medicine, Charlottesville

One of the most important things for the physician to recognize in referring a patient to the orthopedic surgeon for treatment of rheumatoid arthritis is the goal of surgical correction. The primary goal in surgical treatment of diseased joints in the lower extremity is relief of pain. Some pain-free patients have such severe deformities that a surgical procedure may be undertaken in order to improve and restore function, accepting certain calculated risks; however, to improve function surgically in a pain-free joint requires complete and full understanding on the part of the patient as well as the physician.

The Hip Joint. The surgical treatment of rheumatoid disease in the lower extremity has changed drastically in the last ten years. Mold arthroplasty, which was the primary method of treating rheumatoid arthritis of the hip joint until ten years ago, unfortunately did not provide uniform relief of pain and good stability in all patients. In the hands of most surgeons doing mold arthroplasties, the rheumatoid patient got a less satisfactory result than the patient with degenerative arthritis. The major problem with cup arthroplasty in the patient with rheumatoid arthritis was postoperative stiffness and residual pain. Figure 1 illustrates the typical complication following this problem, with the cup settling into the pelvis and the femoral neck shortening under the cup.

The Austin-Moore prosthesis, which was de-

veloped for the treatment of arthritis in the hip joint, subsequently became widely used for the replacement of the femoral head following neck fractures in elderly patients. The use of this prosthesis in rheumatoid disease of the hip was rarely successful. This prosthesis was designed for stability in bone on the basis of a press-fit design. It was doomed to failure in rheumatoid disease of the hip because of inherent osteoporosis, present in most rheumatoids, which allowed the unyielding metal of the prosthesis to protrude into the soft bone of the pelvis and loosen in the soft bone of the femur where the stem of the prosthesis frequently became loose in the canal of the femur. My personal experience with femoral head replacement, using the Austin-Moore or other press-fit design prostheses in rheumatoid arthritis, has been quite disappointing.

Total hip replacement became popular in England about 15 years ago. One of the earliest prostheses used was made of two metallic components similar in design to the Ring prosthesis illustrated in figure 2. Unfortunately, the Ring and other types of press-fit design prostheses were doomed to failure in rheumatoid arthritis for the same reasons that the Austin-Moore prosthesis failed. With our patients, in whom the Ring prosthesis was inserted for rheumatoid arthritis, we had good early results. After a year and a half, however, all but a small number of these patients had painful hips.

Fortunately, polymethylmethacrylate, a bone cement, became available for treating arthritic joints. This surgical cement, used in this country for over five years, is still distributed out of Great Britain.

* Presented by Dr. Thompson at the 45th Annual McGuire Lecture Series, November 8, 1973, at the Medical College of Virginia, Richmond.

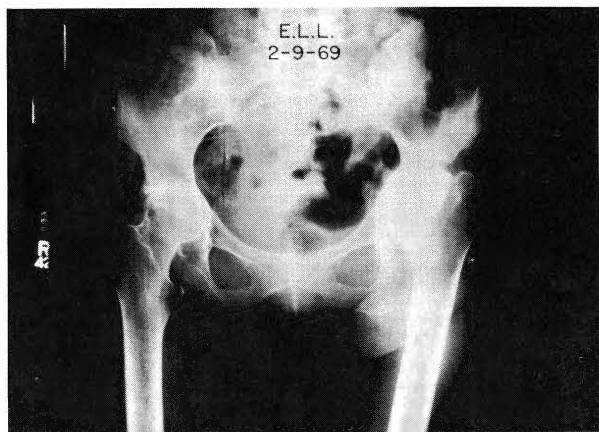

Fig. 1—Cup arthroplasty in a rheumatoid hip which failed because of shortening of femoral neck and protrusion of the cup into the pelvis.

It has allowed us variability and flexibility for inserting all types of total joint replacements utilized in the lower extremities today. This cement has many advantages in a patient with rheumatoid arthritis. In contrast to the press-fit designs, the cement backing of a total joint replacement allows a wide distribution of forces to the bone, and with few exceptions, there has been little settling of the cemented prostheses in rheumatoid arthritis. Charnley (1) certainly deserves the credit for establishing total hip replacement as a method of choice in treating diseased hip joints. Credit goes to him, not only for the design of the prosthesis which he has popu-

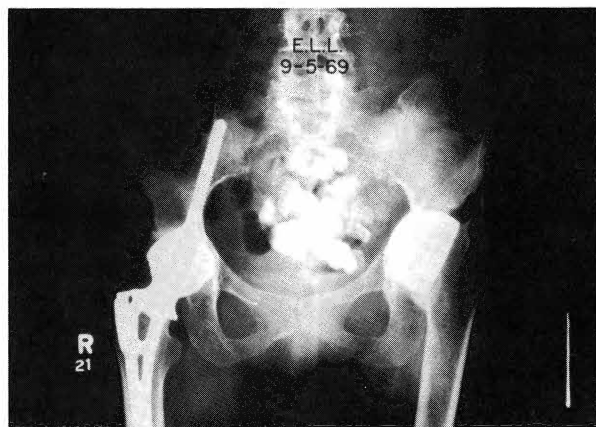

Fig. 2—Ring total hip prosthesis in right hip of rheumatoid patient. A press-fit design which failed with time in the osteoporotic rheumatoid.

The Charnley-Type Total Hip

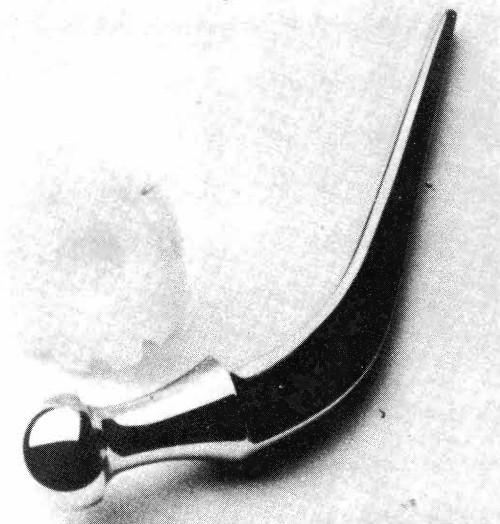

Fig. 3—The Charnley total hip with a 22 mm femoral head of stainless steel and a high density polyethylene acetabulum.

The Charnley-Müller Type Total Hip

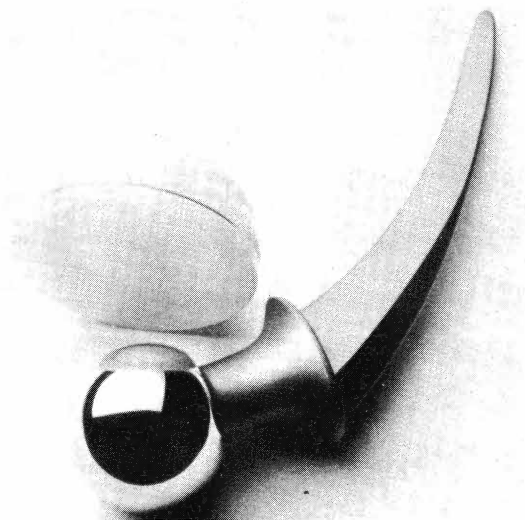

Fig. 4—The Müller total hip with a 32 mm femoral head of cobalt chrome alloy and a high density polyethylene acetabulum.

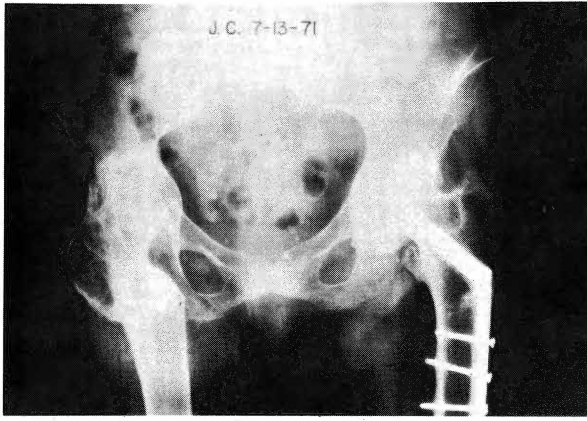

Fig. 5A—Bilateral ankylosed hips in a patient with ankylosing spondylitis. The right hip had previously had a medical displacement osteotomy while the left hip had sustained a fracture and subsequently ankylosed.

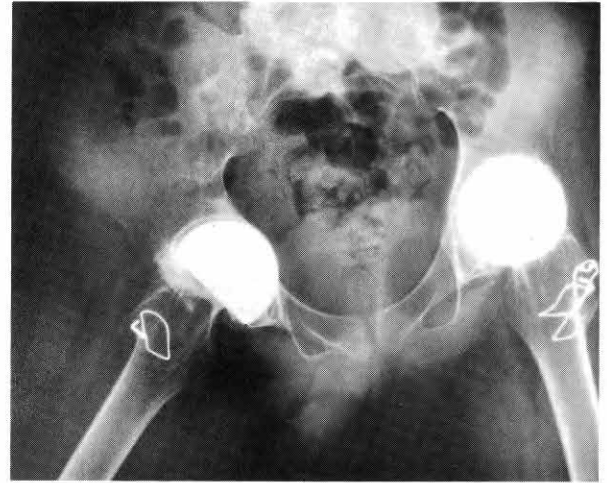

Fig. 6A—Bilateral ankylosed cups in a 20-year-old juvenile rheumatoid.

larized, but also for the fundamental work on bone cement. He did original work on the bone cement even before he began using total hip replacements as we know them today.

One prosthesis which is very popular in this country is the Müller prosthesis (2). Materials used in this prosthesis are similar to those found in the Charnley prosthesis, with a metallic femoral component and a high density polyethylene acetabular component. Charnley's prosthesis (Fig. 3) is made of stainless steel; the Müller prosthesis (Fig. 4) is made of a cobalt chrome alloy.

Rheumatoid arthritis, in a series of hip replacements at the University of Virginia, has made up a relatively small proportion of those patients undergoing total hip replacement. In the first 235 replaced hips, only 35 hips were replaced for rheumatoid arthritis and eight hips for ankylosing spondylitis. In the straightforward rheumatoid arthritic patient with destruction of the hip and painful motion, the results of total hip replacement, using cemented prostheses, have been excellent to date. We have been pleased with the results in patients on whom we performed this procedure and followed for three and one-half years without any significant



Fig. 5B—Postoperative results following bilateral total hip replacements.



Fig. 6B—Postoperative conversion to Harris replaceable-type total hips. Note ectopic bone formation.



Fig. 7A—Preoperative condition of patient with ankylosing spondylitis, fused spine and ankylosed hips (7B).

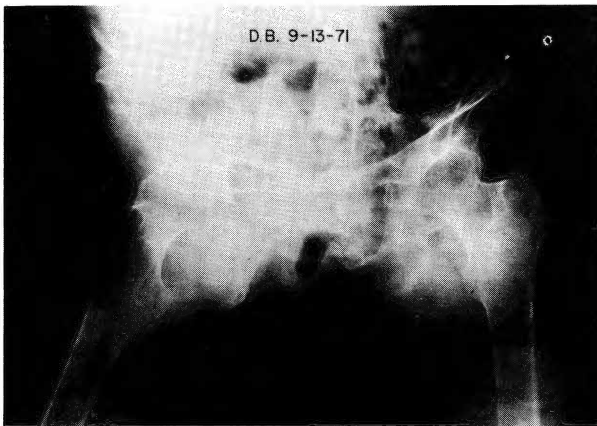

Fig. 7B.

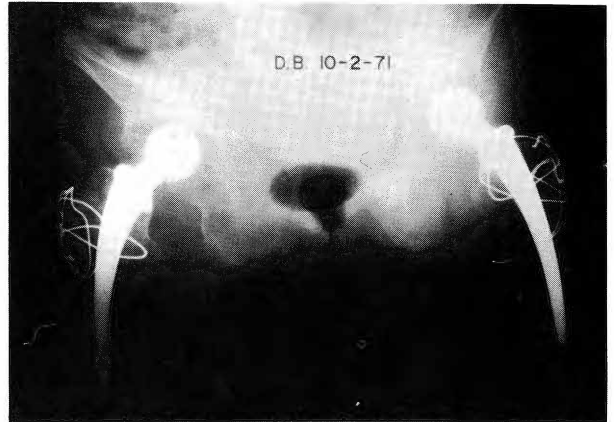

Fig. 7C—Postoperative appearance of hips following bilateral total hip replacements.



Fig. 7D—Condition of patient postoperatively following hip replacements.

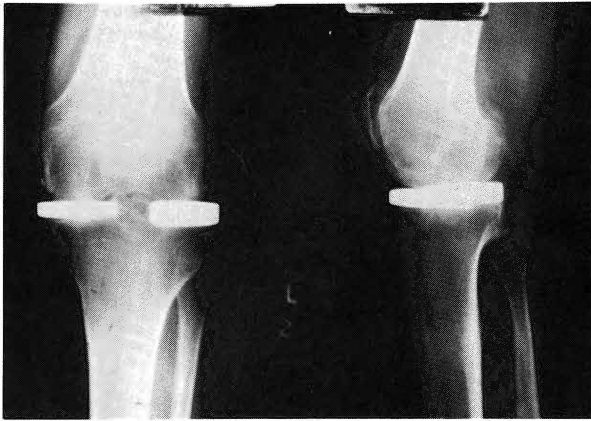

Fig. 8—McIntosh plateau prosthesis four years postoperatively with good results.



Fig. 9—McIntosh prosthesis which failed in rheumatoid two years postsurgery.

failures intrinsic to the rheumatoid process itself.

In order to show the types of problems that are suitable for management with total hip replacement, some of the more unusual cases are presented. A 76-year-old lady with ankylosing spondylitis had a fused spine, a fused right hip, and an ankylosed left hip (Fig. 5A). She had little pain but was unable to sit or drive a car. With some trepidation, we took down her fused hip and used a special type of prosthesis where she had previously had a displacement osteotomy. Following a successful result on this hip, the left hip was replaced (Fig. 5B); she is now able to drive a car, sit, and stand. She does not have normal movement in her hips but has improved markedly in function.

One of the more difficult problems we face is the management of the severe juvenile rheumatoid. A 20-year-old boy had bilateral cup arthroplasties four years prior to surgery (Fig. 6A). Both cups were ankylosed and had no motion. We converted his hips to a special type of total hip replacement designed by Dr. William Harris of Boston (3), using metallic cups which have a replaceable polyethylene liner and a metallic femoral component. This design concept is used to circumvent the problem of wear in the polyethylene. At the present time, all available information suggests wear rates of the polyethylene to be a maximum of 1 mm every five years, suggesting that with the average prosthesis in use today, we can expect a minimum of 20 years function, assuming linear wear rates are present. This particular patient developed a complication of ectopic bone formation around his hip replacements (Fig. 6B), but he is now able to walk, drive a car, and attend college regularly, walking without crutches for the first time in eight years. In addition, prior to surgery, he was unable to sit; he was only able to lie down or stand. At the present time, he can sit, stand, and lie down.

Another difficult case which was dramatically improved by total hip replacements is a 52-year-old lady with ankylosing spondylitis, a fused spine, and hip joints which were ankylosed in 90 degree flexion. She was able to ambulate only with the use of a chair for support (Fig. 7A), and her hip joints were markedly protruded (Fig. 7B). Following bilateral total hip replacement, she was able to stand and see where she was walking, as well as to sit. She did not have a normal gait because of the fused spine but was markedly improved (Fig. 7C, D).

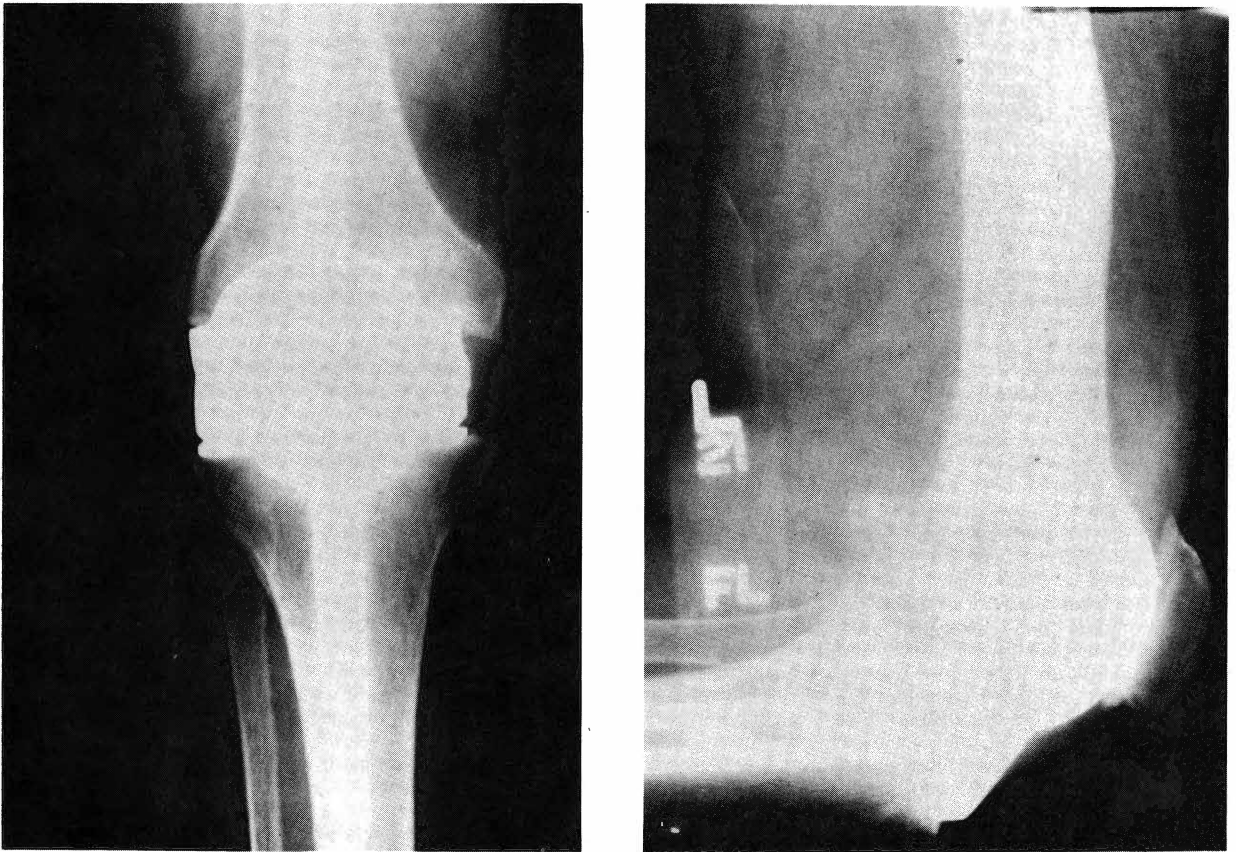

Fig. 10 A, B—Postoperative condition of knee in figure 9, converted to a Walldius hinged prosthesis.

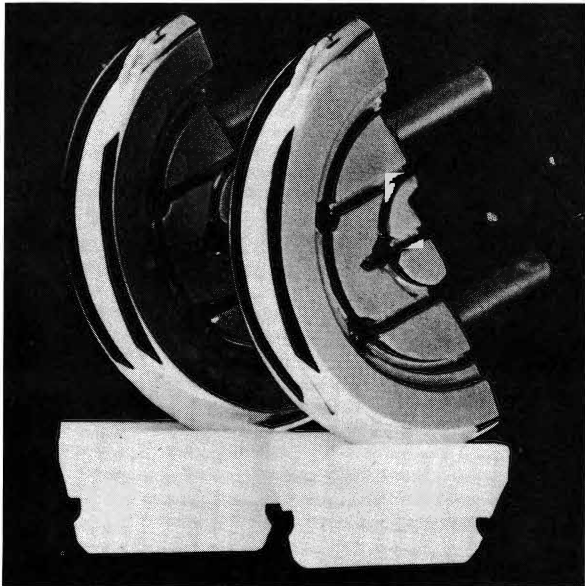

Fig. 11—Polycentric knee joint as modified from Gunston by Bryan and Peterson.

The Knee Joint. As Dr. McDowell points out, synovectomy is a useful procedure if the knee joint cartilage itself and the ligaments around the joint are not destroyed. When there is rampant synovitis, that is, when there is a single joint persistently involved with effusion and synovitis which has failed to respond to adequate medical management over a period of six months, we feel that synovectomy is the treatment of choice.

In patients with bicompartmental knee disease, where both medial and lateral tibial plateaus are involved as well as femoral condyles, arthroplasty is the only successful method of treating the destroyed articular surface. Prior to the advent of total knee replacement, tibial plateau and femoral condylar prostheses were the only surgical treatments available. In our series of patients, we favored the tibial plateau prostheses, designed by McIntosh, and found that some of these replacements did fairly well. The patient in figure 8, now four years post-surgery, is essentially pain free and has an acceptable

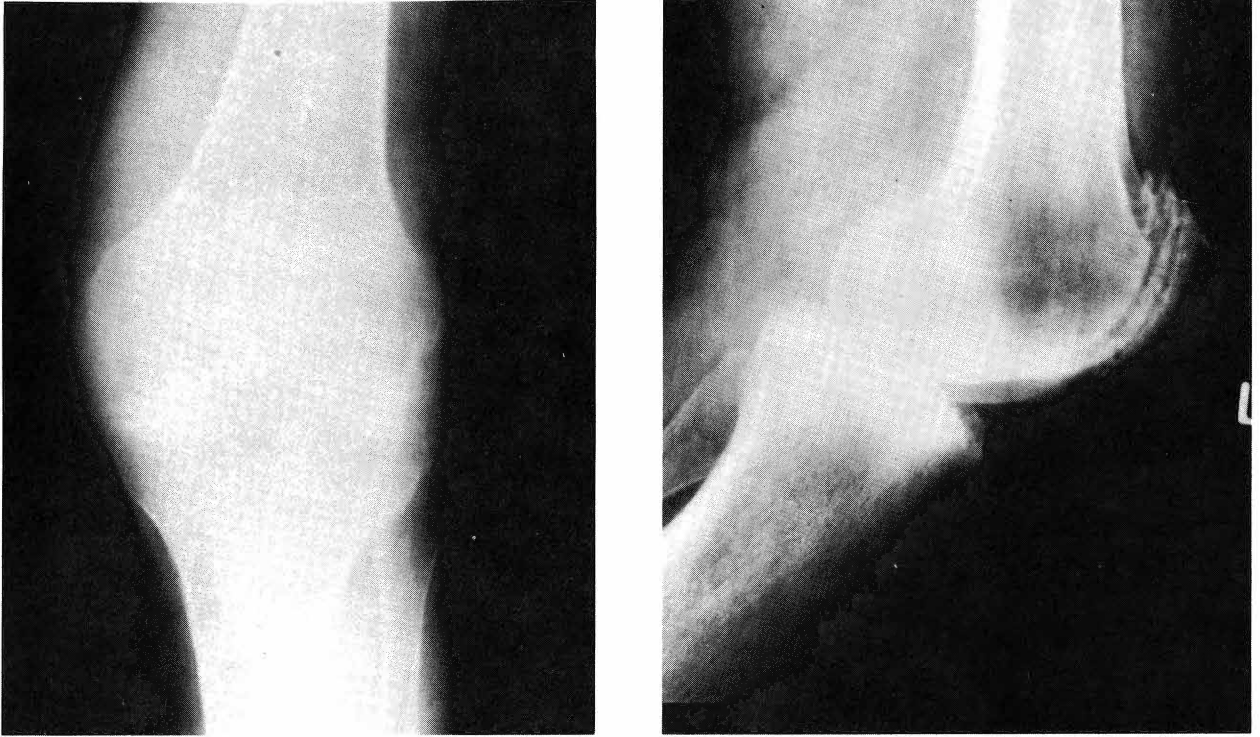

Fig. 12 A, B—AP and lateral x-ray of knee with destruction secondary to rheumatoid arthritis.

range of motion and good stability. Many of these prostheses did not do well and progressed to unstable painful knees. One such patient is a rheumatoid arthritic who lost enough bone following her McIntosh arthroplasty to have severe instability and pain, requiring major joint reconstruction (Fig. 9). We elected to treat this particular problem by use of a large hinged prosthesis designed by Walladius (4) (Fig. 10A, B). Even though this large metallic device has limited motion (90 degrees) and carries a certain incidence of loosening and infection, it has been in use longer than any other knee prosthesis on the market and gives acceptable results in the otherwise unsalvageable knee.

Criteria for Selection of Candidates for Knee Replacement. Initially, we restricted our patients for knee replacement to those over 60 years of age. As we gained experience, we began doing some younger patients in the rheumatoid arthritis group but have continued to restrict our indications in degenerative arthritis to those patients 60 years of age and older.

There are several currently popular prosthetic designs available on the market. All of these are new and little experience has been recorded with

any of these joints. My own preference for a knee prosthesis is the polycentric knee joint as designed by Gunston (5) and modified by Bryan and Peterson (6) (Fig. 11). I prefer this prosthesis because it is embedded in a biologic envelope of bone, has minimal bone cement contact, and has less reliance on cement-prosthesis contact for stability. In the knee joint where there is complete loss of joint space and patellofemoral disease (Fig. 12), we have used the polycentric arthroplasty, composed of two metallic condyles in the femur and plastic runners in the tibia (Fig. 13) with good success. This prosthesis basically allows an increase in space between the femur and tibia and improves motion as well as stability in many knee joints.

Another popular arthroplasty in the United States today is the geometric type (Fig. 14) designed by a group of orthopedic surgeons from four different hospitals (7). This two-piece prosthesis requires resection of more bone than the polycentric arthroplasty, and I have reserved this prosthesis for patients with severe osteoporosis and marked joint destruction with more than 30 degrees of varus or valgus instability. This particular knee joint (Fig. 15) had such severe osteoporosis, the surgeon's



Fig. 13 A, B—AP and lateral x-ray of knee in figure 12 following polycentric arthroplasty.

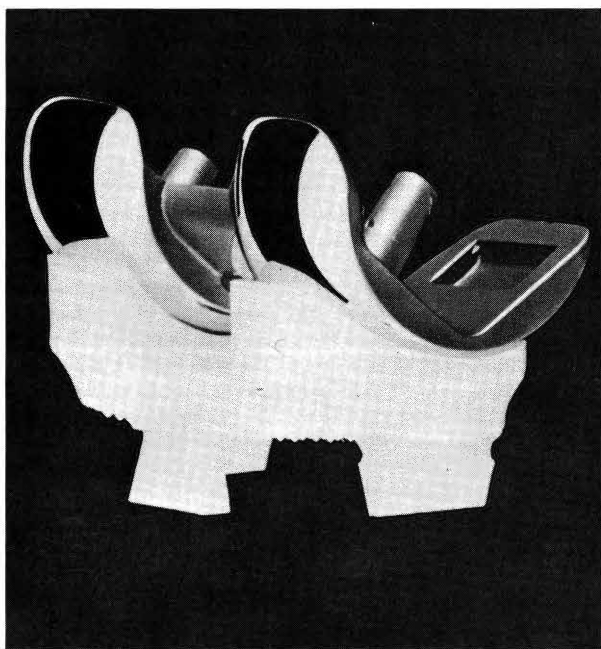

Fig. 14—Geometric knee joint.

thumb could easily be pushed through the femoral condyles. A polycentric type of arthroplasty is extremely difficult to perform in bone as soft as the bone in this particular patient, and the geometric design has allowed us to replace joints of this type providing excellent stability and good motion. The average hospital stay for knee replacements at the University of Virginia is 26 days for unilateral surgery in contrast to an average of 21 days for unilateral hip replacement.

Complications. We have had no cases of phlebitis in our total knee replacements, a fact which may be due to our prophylactic regimen. We use dextran-40 for our total knee replacements, infusing 200 ml of low molecular weight dextran prior to inflation of the tourniquet. The remaining 300 cc are infused after the tourniquet is released. The patients receive 500 cc of dextran-40 daily for three days and then every third day until discharge from the hospital. We have had two cases of hepatitis in our knee replacements—one patient, presumably

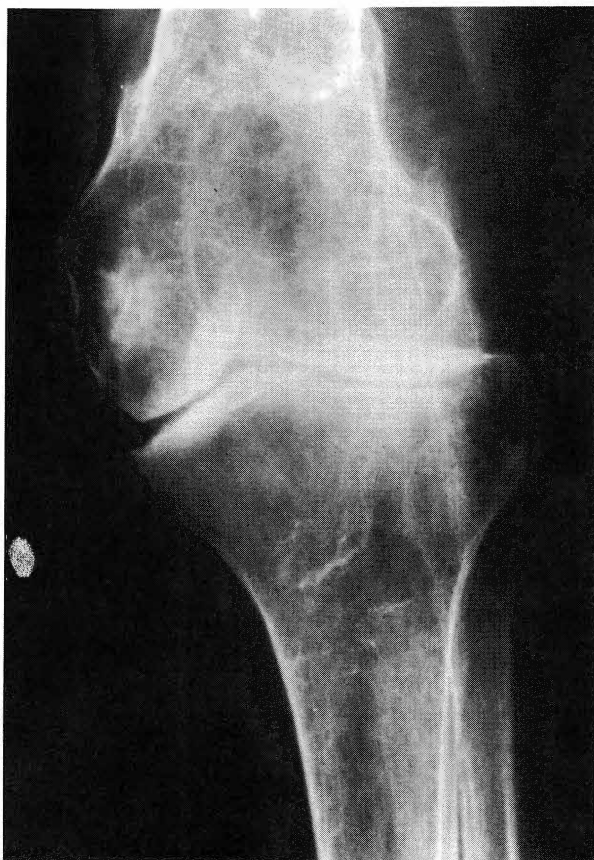

Fig. 15 A, B—Pre- and postoperative x-rays of knee with severe osteoporosis where geometric knee joint was used for arthroplasty.

from a transfusion, and the other, anesthesia-related. We have had no wound infections to date in our knee replacements, which total 35, with a minimum of six months follow-up.

Ankle and Foot. The ankle is a difficult joint to treat in rheumatoid arthritis, primarily because it is rare to have ankle disease alone without subtalar joint disease. Ankle fusion has been successful in several patients I have treated, when the ankle has been involved as an isolated joint. The goal of surgery in this particular problem must be pain relief, as function is rarely improved except as related to relief of pain.

One of the more successful surgical procedures in the lower extremity has been the treatment of forefoot disease in the rheumatoid patient. In those patients with severe hallux valgus and prominent

metatarsal heads on the plantar surface of the foot, resecting the metatarsophalangeal joints has given good pain relief in our hands. Again, function can only be improved on the basis of pain relief.

REFERENCES

1. **CHARNLEY J:** Arthroplasty of the hip: A new operation. *Lancet* 1:1129, 1961.
2. **MÜLLER ME:** Total hip prostheses. *Clin Orthop* 72:46, 1970.
3. **HARRIS WH:** A new total hip implant. *Clin Orthop* 81:105, 1971.

4. **WALLDIUS B:** Arthroplasty of the knee using an endoprosthesis. *Acta Orthop Scand* 30:137, 1960.
5. **GUNSTON F:** Polycentric knee arthroplasty. *J Bone Joint Surg* 53B:272, 1972.
6. **BRYAN RS, PETERSON LF:** The quest for the replacement knee. *Orthop Clin North Am* 2:715, 1971.
7. **COVENTRY MB, UPSHAW JE, RILEY LH, FINERMAN GAM, TURNER RH:** Geometric total knee arthroplasty. *Clin Orthop* 94:171, 1973.

Diagnostic Concordance of Serological Tests for Antiglobulin Antibodies* **

MARION WALLER, PH. D.

*Professor of Medicine, Division of Connective Tissue Diseases,
Medical College of Virginia, Health Sciences Division of Virginia
Commonwealth University, Richmond*

Rheumatoid factors are present in a variety of disease states and in normal persons, usually in low titer. High titers of rheumatoid factors are almost exclusively associated with rheumatoid arthritis.

A second group of antiglobulin antibodies, called serum agglutinators, distinct from rheumatoid factors, are anti-Fab IgG antibodies presumably present in the sera of all mammals. High titers of these antibodies are not diagnostic for a specific disease but are closely associated with suppurative infection which is usually due to gram-positive organisms.

Tests for determining the titers of the serum agglutinators are used as diagnostic aids for hidden abscesses. In suppurative infection, and especially in gram-positive septicemia, titers are very high. Elevated titers have aided in differentiating osteomyelitic abscesses from destructive tumor lesions of the bone. The titers of the serum agglutinators will fall when the suppurative lesions resolve; thus, falling titers of these antibodies help in evaluating the resolution of large lesions. In addition, the failure of the patient to respond with a rise in titer in the face of significant or multiple abscesses is usually a warning that the patient is not immuno-

logically competent, such as patients with thymoma, lymphoma or myeloma. Figure 1 demonstrates the method used for studying both of these antiglobulin antibodies.

Rh-positive erythrocytes coated with the incomplete anti-Rh antibody, Ripley, are used to demonstrate the rheumatoid factors. These anti-Rh antibodies, hydrolyzed with various enzymes, are used to demonstrate the different serum agglutinators. Erythrocytes coated with a mixture of intact antibodies and the Fab fragments of antibodies will permit the demonstration of both antibodies.

This prospective study of 1,320 persons, whose sera were examined for the presence of both rheumatoid factors and serum agglutinators, was undertaken to evaluate and compare the effectiveness of the tests for these two distinct antiglobulin antibodies as diagnostic aids in rheumatoid arthritis and suppurative infection, respectively. Three groups of patients were tested:

Group 1 (hospital patients)—Serum specimens from 181 hospital patients were sent to our laboratory primarily to be tested for the presence of serum agglutinators.

Group 2 (ambulatory patients)—Serum specimens from 926 patients attending the connective tissue (rheumatology) clinics were sent to our laboratory to be tested for the presence of rheumatoid factors.

Group 3 ("normal" persons attending the city venereal disease clinic)—Serum specimens were obtained from 213 persons attending the venereal disease clinic. They were primarily young adults,

* Presented by Dr. Waller at the 45th Annual McGuire Lecture Series, November 9, 1973, at the Medical College of Virginia, Richmond.

** This is publication No. 65 from the Charles W. Thomas Arthritis Fund, Medical College of Virginia, and was supported in part by the Herbert L. Earnest Arthritis Fund for research.

Reprint requests to Dr. Marion Waller, Department of Medicine, Medical College of Virginia, Richmond, Virginia 23298.

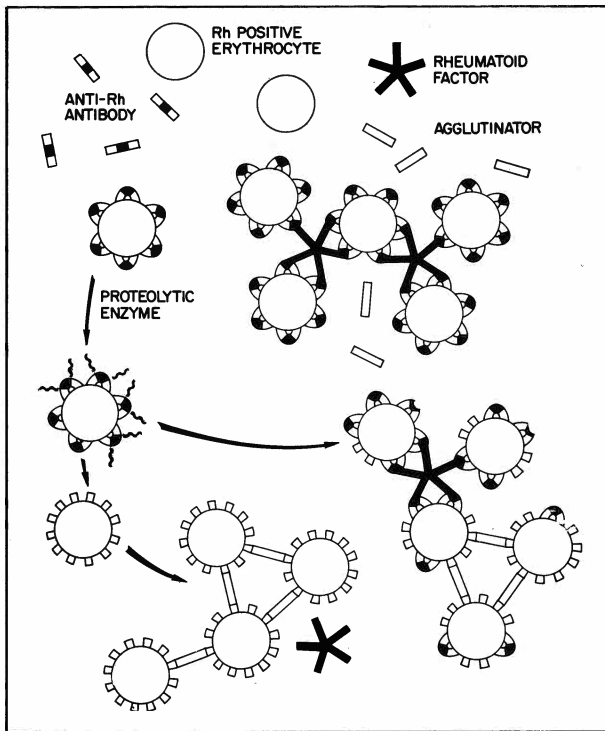

Fig. 1.

some with and some without complaints of urethral or vaginal discharge. Neither antiglobulin test was ordered; these were used as a control group.

For this study, only titers of 160 or above were considered as positive tests. Table 1 shows the results of the tests for rheumatoid factors and serum agglutinators in 1,320 patients. The incidence of positive tests for serum agglutinators was highest in the hospitalized patients (group 1), whereas the incidence of positive tests for rheumatoid factors was highest, understandably, in the patients attending the rheumatology clinic (group 2). In the patients attending the venereal disease clinic (group 3), the incidence for both types of antiglobulin antibodies was only 1-2%.

Table 2 shows the variety of diseases among the 181 hospital patients. The association between positive tests for serum agglutinators and suppurative infection is apparent. In patients with pneumonia, suppuration is variable; in addition, there is natural drainage, and the patients receive early therapy. Thus positive tests are not usual. The incidence of positive tests in patients with localized infections depends upon the severity of the lesion. In neither malignancy nor metabolic disease are

TABLE 1
INCIDENCE OF POSITIVE TESTS FOR ANTIGLOBULIN ANTIBODIES*

Study Group	Total No. Patients	Test for Rheumatoid Factors		Test for Serum Agglutinators	
		No. Positive	Percent Positive	No. Positive	Percent Positive
1	181	13	7.1	27	14.9
2	926	148	16.0	5	0.5
3	213	3	1.4	4	1.9
Totals	1,320	164	12.4	36	2.7

NOTE. Group 1 = hospital patients. Group 2 = patients attending the rheumatology clinic. Group 3 = patients attending the venereal disease clinic.

* Reprinted by permission from *Am J Med* 54: 731-734, 1973.

TABLE 2
TESTS FOR SERUM AGGLUTINATORS IN 181 HOSPITAL PATIENTS (GROUP 1) WITH A VARIETY OF DISEASES*

Infection	Patients (no.)	
	Total	Positive Test
Gram-negative septicemia	2	—
Pyelonephritis	6	1
Pneumonia	11	1
Granulomatous infection	8	2
Subacute bacterial endocarditis	3	3
Large abscesses (empyema, osteomyelitis)	19	12
Infections associated with immunologic deficiency (lymphoma, thymoma, myeloma, transplantation)	5	—
Localized infection (gonorrhoea, pyoderma tonsillitis, infectious arthritis, wound infection, decubitus ulcers)	25	4
Malignancy	14	—
Connective tissue diseases (rheumatoid arthritis, lupus, gout)	19	2
Undiagnosed (fever of undetermined origin)	15	1
Metabolic disease (diabetes, nephrosis, toxic drugs, muscular dystrophy, alcoholism, cardiovascular disease)	54	1
Totals	181	27

* Reprinted by permission from *Am J Med* 54: 731-734, 1973.

these antibodies present in high titer. The exception in this instance was a patient with chronic alcoholic cirrhosis, hematuria and a hemolytic anemia of unknown etiology. Among the patients with connective tissue disease were a two-and-a-half-year-old child with lupus erythematosus and a young boy with juvenile rheumatoid arthritis; both had high titers of serum agglutinators. In neither of these diseases are the tests usually positive. It was the first hospital admission for both children, however, and the possibility that titers may be high in early and explosive disease and then decline in the chronic state cannot be ruled out. Neither child had a positive test for rheumatoid factor or for lupus erythematosus.

Table 3 shows the correlation (or lack of it) between the positive test and the disease for which the test was ordered. The serum agglutinator test was ordered for the hospitalized patients (group 1); the rheumatoid factor test was ordered for the patients attending the rheumatology clinic (group 2); and neither test was ordered for the patients attending the venereal disease clinic (group 3). In 13 of the 181 hospitalized patients, the tests for rheumatoid factors were positive but only six of the 13 had rheumatoid arthritis. Thus, the correlation between positive test and disease state was only 46.2%. Among the same patients, however, 21 of 27 with positive tests for serum agglutinators had suppurative infection.

In the patients attending the rheumatology clinic (group 2), there was a very high correlation

TABLE 3

PRESENCE OF RHEUMATOID ARTHRITIS OR SUPPURATIVE INFECTION IN PATIENTS WITH POSITIVE TESTS FOR RHEUMATOID FACTORS OR SERUM AGGLUTINATORS*

Study Group	Rheumatoid Factor Test Positive	Rheumatoid Arthritis Present	Percent Correlation	Serum Agglutinator Test Positive	Suppurative Infection Present	Percent Correlation
1	13	6	46.2	27	21	77.7
2	148	145	98.0	5	0	None
3	3	0	None	4	1	25.0
Totals	164	151	92.0	36	23	63.0

* Reprinted by permission from *Am J Med* 54: 731-734, 1973.

TABLE 4

FALSE-POSITIVE TESTS FOR ANTIGLOBULIN ANTIBODIES*

Study Group	Total No. Patients	Rheumatoid Factor Test		Serum Agglutinator Test	
		No. Positive Without Rheumatoid Arthritis	Percent False-Positive	No. Positive Without Suppurative Infection	Percent False-Positive
1	181	7	3.8	6	3.3
2	926	3	0.3	5	0.5
3	213	3	1.4	3	1.4
Totals	1,320	13	0.9	14	1.0

* Reprinted by permission from *Am J Med* 54: 731-734, 1973.

between the positive test for rheumatoid factor and the presence of rheumatoid arthritis. Of these 926 patients, five had a positive test for serum agglutinators (0.5%), but none had a suppurative infection.

Of the 213 patients attending the venereal disease clinic (group 3), three had a positive test for rheumatoid factor (1.4%). Only one of these three had gonorrhea. None had rheumatoid arthritis. Of these 213 patients, four had a positive test for serum agglutinators (1.9%). Only one had gonococcal urethritis.

If the results of tests for rheumatoid factors and serum agglutinators, as standardized in this study, are evaluated for correlation of the test with specific disease, the percentages of false-positive tests among the hospitalized patients (group 1) are 3.8% and 3.3%, respectively; among the patients attending the rheumatology clinic (group 2), 0.3% and 0.5%, respectively; and among patients attending the venereal disease clinic (group 3), 1.4% and 1.4%, respectively (Table 4). These percentages of false-positive tests are much higher when titers lower than those used as the standard in this study are accepted as positive tests.

Comments. The requirements for a positive test for rheumatoid factors in this study are more stringent than those used in other studies. Even so, only 46.2% of group 1, with rheumatoid factor titers of 160 or above by the sensitized human cell test, had rheumatoid arthritis. The sensitized sheep cell tests were positive for rheumatoid factor in three

of the hospitalized patients in the absence of rheumatoid arthritis; the diagnoses in these were Wegener's granuloma, chronic heart failure, and sarcoidosis. Thus, it is necessary to conclude that among very sick patients, positive tests for rheumatoid factors only correlate with rheumatoid arthritis about 50% of the time. In patients in whom there is a high degree of suspicion of the disease, however, the correlation is about 98%. It is also obvious that among ambulatory patients attending a clinic for a completely unrelated disease, positive tests for rheumatoid factors are not apt to correlate with rheumatoid arthritis.

Among the 181 hospitalized patients, 27 (15%) had elevated titers of serum agglutinators, which reflects the interest in infection in this group of patients, since the test ordered was for the serum agglutinators. Positive tests for serum agglutinators

are unusual in nonhospitalized patients and as a rule, those who do have positive tests do not have severe suppurative infection. In many instances, however, these tests might be helpful in differentiating a hidden abscess from a malignancy. Sometimes, a well-walled-off abscess will cause only modest elevations in the titers of the serum agglutinators, whereas, when the abscess is pierced, its inevitable discharge will stimulate the serum agglutinators and the titers will rise. As resolution of the lesion occurs, the titers will fall.

This study lends credence to the postulate that rheumatoid factors are humoral heterophil antibodies that may be stimulated by a variety of immunologic events. As stated, the correlation of positive tests for these antibodies with rheumatoid arthritis is only about 50% in very sick hospitalized patients.

Still's Disease in Adults* **

WILLIAM M. EDWARDS, M. D. AND STEPHEN R. KOLLER, M. D.

*Fellows in Rheumatology, Division of Connective Tissue Diseases,
Medical College of Virginia, Health Sciences Division of Virginia
Commonwealth University, Richmond*

MICHAEL J. MILLER, M. D.

*Senior Assistant Resident in Medicine, Department of Medicine,
Medical College of Virginia, Health Sciences Division of Virginia
Commonwealth University, Richmond*

In 1897, Dr. George F. Still described 22 children with a form of chronic joint disease which differed from rheumatic fever (1). Twelve of these children had a syndrome characterized by glandular and splenic enlargement which, with a characteristic fever pattern, rash, and arthritis, has become known as Still's disease (2). Subsequent investigators have described patients over age 16 presenting with similar signs and symptoms suggesting that this syndrome is not specific for children (3, 4, 5, 6). We recently studied a patient in whom the diagnosis of adult onset Still's disease was made.

Case. J. O. is a 44-year-old male who was referred to the Medical College of Virginia Hospitals (MCVH) on May 22, 1973 for evaluation of fever of 12 weeks duration. In addition to the fever, he had a 25 pound weight loss over a four month period, shaking chills, drenching night sweats, and progressive weakness and anorexia. Two months prior to admission, pain developed in his right knee and soon progressed to involve the right great toe, both wrists, and fingers of both hands. Aspirin at variable doses, prescribed by his private physician,

was not helpful. He had been admitted to another hospital on May 7, 1973, where he underwent extensive laboratory and radiological evaluation, but the cause of his symptoms was not ascertained and he was transferred to MCVH for further diagnostic investigation.

Past medical history revealed that 12 years earlier, he had been seen in another hospital for arthritis involving his right wrist which quickly resolved. He acknowledged mild morning stiffness in his fingers for several years prior to his present illness but denied swelling, heat, redness, or decreased function in any joint. Adult onset diabetes mellitus had been diagnosed one year earlier and had been treated with tolbutamide, 500 mg daily.

Family history was noncontributory. The patient lives in a rural setting and is employed as a maintenance worker in a local seat belt factory. He denied the use of cigarettes or alcohol.

Physical examination on admission revealed a T 102°F (39°C), P 92/min., BP 110/58. He was in no distress. Pertinent findings included a congenital terminal nystagmus on lateral gaze and numerous nontender, firm, small, freely movable lymph nodes in the anterior cervical region, right axilla, left inguinal, and left epitrochlear areas. The lungs and heart were normal. The liver measured 10 cm and was palpable 2 cm below the right costal

* Presented by Drs. Edwards, Koller, and Miller at the 45th Annual McGuire Lecture Series, November 9, 1973, at the Medical College of Virginia, Richmond.

** This is publication No. 68 from the Charles W. Thomas Arthritis Fund.

margin on deep inspiration. The spleen was not palpable. The right knee contained a moderate effusion but was neither warm nor tender. Both wrists were tender and evoked pain on passive range of motion. The remainder of the physical examination was normal.

Representative hematological values were: hemoglobin 10 gm%, WBC 12,000/mm³ with 75% PMN's, 20% lymphocytes, 5% mononuclear cells, and an ESR 66 mm/hr. (Wintrobe). Representative chemistries included an albumin 3.2 gm%, total bilirubin 0.3 mg%, alkaline phosphatase 125 mU/ml, lactic dehydrogenase (LDH) 325 mU/ml (LDH-4 and 5 isozymes elevated), and serum glutamic oxaloacetic transaminase (SGOT) 70 mU/ml. The following tests were either normal or negative: urinalysis, blood cultures, latex flocculation, antinuclear antibody test (ANA), LE cell preparations, HBAg (by CEP), heterophil, T₃, T₄, sickle cell preparation, serologic test for syphilis (STS), blood urea nitrogen (BUN), creatinine, calcium, phosphorus, uric acid, amylase, antistreptolysin-O (ASO) titer, febrile agglutinins for typhoid, brucella, proteus, tularemia, and toxoplasmosis. Several blood sugar determinations were above the normal range, the highest being 180 mg%. Intermediate and second strength PPD's were negative and a mumps antigen elicited 15 mm of induration. Examination of the cerebrospinal fluid and bone marrow was not helpful. Routine and tuberculosis (Tbc) cultures from synovial fluid, urine, sputum, bone marrow, spinal fluid, and liver were negative. Upper gastrointestinal series (UGI), barium enema, IVP, hand, wrist, and chest x-ray studies were normal. Cervical spine films showed only mild degenerative arthritis. A liver scan was normal. Serum protein electrophoresis showed increased α -1 and α -2 globulins only. Analysis of synovial fluid from his right knee revealed a WBC 1,144/mm³ with 30% polymorphonuclear leukocytes (PMN's), 31% lymphocytes, and 39% mononuclear cells.

A biopsy of subcutaneous tissue from the patient's left forearm showed a granulomatous reaction with moderate vasculitis and lipid-filled macrophages. He underwent an exploratory laparotomy with celiac lymph node and liver biopsies. Histopathological interpretation of the liver was reactive hepatitis compatible with a number of systemic diseases and the lymph node showed chronic

lymphadenitis with lipoid granuloma. A congo red stain for amyloid was negative.

The patient was discharged June 25, 1973 on 3.6 grams of salicylates per day in divided doses. Because of his mild glucose intolerance, it had not been felt necessary to supplement his diabetic diet with any drug therapy. He was readmitted July 15, 1973 because of persistent quotidian fever, pain in his proximal interphalangeal joints, and morning stiffness. In addition, he now complained of pruritus over his entire body associated with temperature elevations, although no rash was present. He had gained five pounds since the first admission. At this time he was found to have pain over the medial aspect of his right ankle. X-rays of his hands and wrists now revealed patchy osteoporosis and cystic lucencies involving the radial styloid and proximal row of carpal bones (Fig. 1). He was discharged July 25, 1973 on salicylates and Benadryl® with a diagnosis of seronegative rheumatoid arthritis.

Outpatient visits over the next two months documented continued quotidian fever (Fig. 2) and progressive arthritis, and on September 27, 1973, he was readmitted to the hospital. A maculopapular rash, lasting hours, mostly on his arms, now accompanied the temperature elevations. A synovial biopsy of the right knee was performed showing nonspecific chronic synovitis (Fig. 3). Serologic testing continued to be negative. A diagnosis of adult onset Still's disease was made and, in addition to salicylates, gold therapy was instituted.

Over the ensuing months, the patient has felt better, has gained 17 pounds, and has experienced general improvement of his joint symptoms. The general malaise, anorexia, night sweats, chills, and persistent quotidian fever have abated. He still, however, has an occasional temperature elevation with an associated fleeting rash.

Discussion. Despite the increasing sophistication of the practice of medicine and its effect on our diagnostic capabilities, certain patients continue to baffle the most astute clinicians with fever of undetermined origin (FUO). Many of these patients turn out to have neither infectious nor neoplastic disorders but, rather, connective tissue diseases, such as rheumatoid arthritis (RA), systemic lupus erythematosus (SLE), or even acute rheumatic fever (ARF) (7, 8). Still's disease, which is commonly included among the causes of FUO's in children, has been shown to persist or recur in adulthood

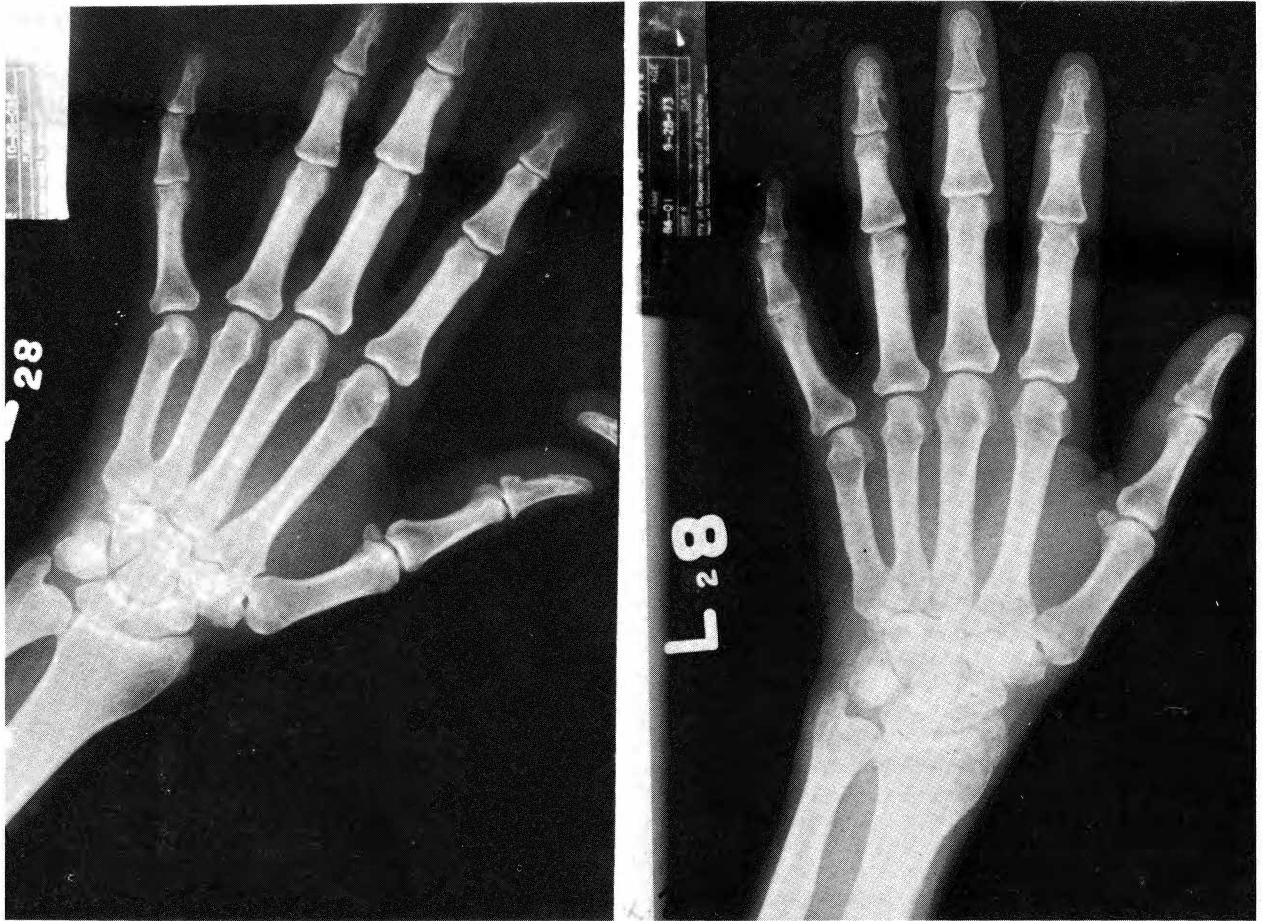

Fig. 1—The hand and wrist on the left are normal in May 1973. A subsequent x-ray of the same joints in September 1973, illustrates the cystic lucencies and osteoporosis.

(5, 9). In recent years, however, attention has focused on a syndrome indistinguishable from childhood Still's disease occurring *de novo* in adults (3, 4, 5, 6).

Although there is no pathognomonic finding in adult onset Still's disease, certain features may be diagnostically useful. A quotidian fever pattern is the rule rather than the exception. This quotidian pattern may, however, be preceded or succeeded by a remittent or even double quotidian pattern. It has been pointed out, also, that the fever may be present for weeks or for months before arthritis develops (2, 5). Often, in association with the temperature elevations, a macular or maculopapular rash is noted particularly in areas of pressure or friction. This migratory, evanescent eruption may recur for months in adult onset Still's disease in contrast to that of acute rheumatic fever which

rarely persists longer than two weeks (2, 3, 5). Of historical interest concerning the rash of RA and juvenile rheumatoid arthritis (JRA), in 1956 Isdale and Bywaters (10) reported four adults who developed a rash in association with other systemic manifestations indistinguishable from Still's disease. It was not until 1971, however, that these same women, along with ten others, were the clinical material for Bywaters' original description of adult onset Still's disease (3). Many biopsies of the rash in adult onset Still's disease have been described, yet they all show nonspecific histology, that being a mild subepithelial and perivascular polymorphonuclear leukocyte infiltrate (3, 4, 5, 10).

Lymphadenopathy and splenomegaly correspond significantly with the high fever, rash, and leukocytosis in childhood Still's disease (11). While no mention was made of lymphadenopathy, By-

waters (3) did note splenomegaly in two of his patients with adult onset Still's disease, whereas six out of ten of those cases reported from the National Institutes of Health (NIH) had splenomegaly and seven had lymphadenopathy. As in our patient, the liver may be involved with an inflammatory infiltrate which may recur with relapses of the disease and return to normal after recovery (5).

It has been said that chronic erosive arthritis involving cervical spine, sacroiliac, temporomandibular, or peripheral joints may occur in a third or more of children with acute onset JRA (11, 12, 13). Radiographic studies of these areas have not been helpful in the adult form of JRA. Although erosive arthritis including cervical spine involvement has been documented in seven of 26 cases, it is usually not severe or widespread (3, 4, 5). On the other hand, arthralgias or nonerosive arthritis may be very common but transient (3, 4, 5). The histology of the synovium may vary in severity from a very mild inflammatory reaction as reported by Bywaters (3) to a very intense inflammatory response as reported by Fabricant *et al.* (4).

In addition to the more characteristic features of adult onset Still's disease, namely fever, rash, lymphadenopathy, and arthralgias or nonerosive arthritis, one may encounter less specific symptoms. Myalgias, particularly of the lumbar, cervical, or thigh regions, sore throat, alopecia, pericarditis pneumonitis, and pleurisy, with or without a pleural effusion, have been described. Abdominal pain may occur which possibly reflects mesenteric lymphadenitis (5). In contrast to JRA, especially the oligo-

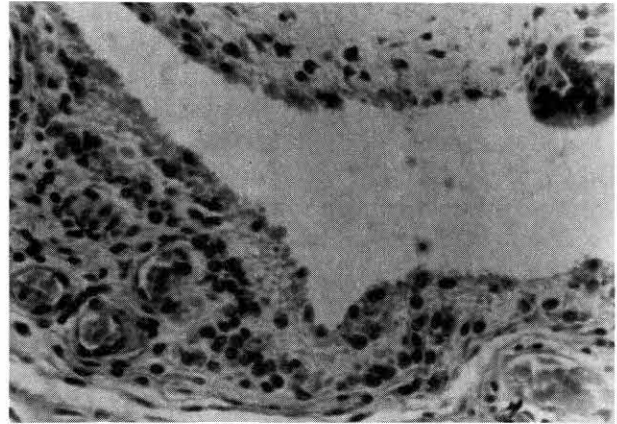

Fig. 3—Light microscopy of synovium obtained by needle biopsy shows synovial lining cell proliferation and round cell infiltration with edema and endothelial proliferation of the sublining tissue.

articular form, iridocyclitis is notably absent in adult onset Still's disease. Likewise, rheumatoid nodules are not found.

As in many other connective tissue disorders, laboratory confirmation of adult onset Still's disease is not possible. Characteristically, rheumatoid factor is not found in the sera of these patients. Probably the most helpful finding is a neutrophilic leukocytosis. Of 12 patients with adult onset Still's disease, ten had WBC's greater than $18,000/\text{mm}^3$ with over 70% neutrophils. Similarly, the ESR is elevated and often parallels disease activity (3, 4, 5). In only two patients with adult onset Still's disease has synovial analysis been reported, one showing a white opaque fluid with $69,000 \text{ WBC}/\text{mm}^3$ and the other, a yellow turbid fluid with $14,000 \text{ WBC}/\text{mm}^3$. In both aspirates, over 90% of the cells were polymorphonuclear leukocytes (4).

Because of the therapeutic and prognostic implications, physicians should be especially aware of a syndrome occurring in an adult, which is indistinguishable from Still's disease. Salicylates in doses which maintain a serum level of 25–30 mg% may induce symptomatic relief in many patients with adult onset Still's disease. Others do not respond as favorably and may require additional therapy. Of the ten patients with adult onset Still's disease comprising the NIH study, four responded to high-dose aspirin or indomethacin therapy (5). Chloroquine, used in conjunction with aspirin, reportedly maintained a normal ESR and good func-

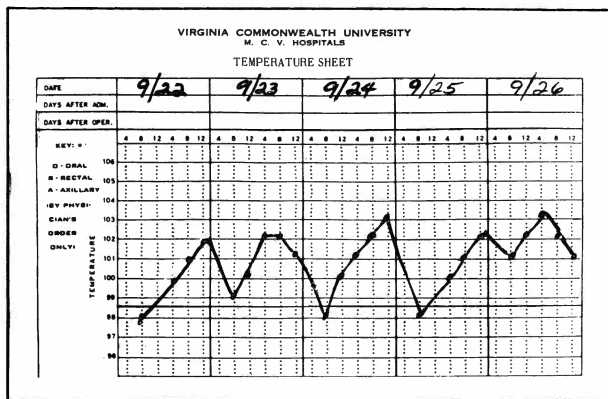

Fig. 2—Oral temperatures recorded by the patient show the characteristic quotidian fever pattern of adult onset Still's disease.

tional state in one of Bywaters' patients, although erosive carpal bones and ankylosis of C 2-3 were present (3). Ultimately, however, the majority of patients with adult onset Still's disease have been treated with prednisone. Alternate-day therapy is preferred if one must resort to steroids; however, it has been noted by Bujak *et al.* (5) that symptoms recur on the off day unless the steroids are accompanied by very high salicylate doses. Even steroid therapy may not fully suppress the activity of adult onset Still's disease. One patient who subsequently had a remission on gold therapy was reported by Fabricant *et al.* (4) to have experienced active symptoms despite 30 mg of prednisone daily. The only other mention of gold therapy in adult onset Still's disease has been by Bywaters in his original series, where he commented on two patients who improved while taking gold. In one patient, the gold therapy was instituted while steroids were being withdrawn and in the other patient, it was given in addition to aspirin and prednisone (3). Thus, our patient represents the only report to date of a patient with adult onset Still's disease responding to gold therapy without previous or concomitant corticosteroid therapy.

Conclusion. A patient with adult onset Still's disease and a review of the literature pertinent to this syndrome is presented. Several features should be emphasized: 1) Adult onset Still's disease should be considered in those patients with FUO who have an evanescent rash, leukocytosis, arthritis, or arthralgias and lymphadenopathy. 2) The prognosis of adult onset Still's disease is good with few patients, so far reported, developing chronic erosive arthritis. 3) The majority of patients with adult onset Still's disease will respond to salicylates, although some will require corticosteroids or gold therapy.

REFERENCES

1. **STILL GF:** On a form of chronic joint disease in children. *Med Clin Trans* 80:47, 1897, as reprinted in *Arch Dis Child* 16:156, 1941.
2. **CALABRO JJ, MARCHESANO JM:** The early natural history of juvenile rheumatoid arthritis. *Med Clin North Am* 52:567, 1967.
3. **BYWATERS EGL:** Still's disease in the adult. *Ann Rheum Dis* 30:121, 1971.
4. **FABRICANT MS, CHANDOR FB, FRIOU GJ:** Still's disease in adults: A cause of prolonged undiagnosed fever. *JAMA* 225:273, 1973.
5. **BUJAK JS, APTEKAR RG, DECKER JL, WOLFF SM:** Juvenile rheumatoid arthritis presenting in the adult as fever of unknown origin. *Medicine* 52:431, 1973.
6. **APTEKAR RG, DECKER JL, BUJAK JF, WOLFF SM:** Adult onset juvenile rheumatoid disease. *Arth Rheum* 16:715, 1973.
7. **PETERSDORF RG, BEESON RB:** Fever of unexplained origin: Report on 100 cases. *Medicine* 40:1, 1961.
8. **JACOBY GA, SWARTZ MN:** Fever of undetermined origin. *N Engl J Med* 289:1407, 1973.
9. **JEREMY R, SCHALLER J, ARKLESS R, WEDGWOOD RJ, HEALEY LA:** Juvenile rheumatoid arthritis persisting into adulthood. *Am J Med* 45:419, 1968.
10. **ISDALE IC, BYWATERS EGL:** The rash of rheumatoid arthritis and Still's disease. *Q J Med* 25:377, 1956.
11. **CALABRO JJ, MARCHESANO JM:** Fever associated with juvenile rheumatoid arthritis. *N Engl J Med* 276:11, 1967.
12. **CALABRO JJ, MARCHESANO JM:** Classification of juvenile rheumatoid arthritis. *N Engl J Med* 277:1374, 1967.
13. **ANSELL BM, BYWATERS EGL:** Diagnosis of probable Still's disease and its outcome. *Ann Rheum Dis* 21:253, 1962.

Genetic-Metabolic News

One of the primary aims of the genetic counselor is the reduction in the number of children born with either lethal disorders or severe CNS dysfunction (eg. mongolism and midline neural defects). Generally, this goal is accomplished in one of four major ways:

- 1) Where a child's disorder is known to be inherited in a Mendelian fashion, by clearly stating the recurrence risk of 1:2 or 1:4, which is often a deterrent to a parent pair to plan further pregnancies;
- 2) By counseling based on empirically established recurrence risk statistics;
- 3) Where the risk is high, by determining the status of the fetus at 14-16 weeks by aspiration and study of amniotic fluid (amniocentesis)—when the mother is over age 40, or has had a previous child with mongolism, a sex-linked disorder, or one of some fifty metabolic disorders which may be diagnosed by amniotic fluid study, the pregnancy can be terminated before twenty weeks gestation if one of the disorders is detected;
- 4) By ascertainment of parent pairs where both are carriers of an autosomal recessive disorder *before* birth of an involved child so that parents may be advised of the high risk of occurrence of this disorder in their offspring and also be advised of the availability or nonavailability of intrauterine diagnosis by amniocentesis.

At present, two carrier detection programs (for sickle cell anemia and Tay-Sachs disease) have been developed because the following necessary criteria have been met:

- 1) The carrier test is rapid, accurate, and inexpensive within a defined population;
- 2) The frequency of the carrier state is high enough within a defined population to justify the cost of testing;

3) The disorder is a serious health hazard for which there is no definitive cure.

One other disorder, cystic fibrosis (rare in the Black race) meets criteria 2 and 3 but unfortunately, not 1. As soon as an effective carrier test for this disease is developed, however, it will be offered to whites just as today, blacks have available sickle cell testing and Jews, a Tay-Sachs screening test.

The major purpose of this article is to briefly summarize the concept of a Tay-Sachs carrier detection program and to share our experiences in Virginia. This disease, first described by Drs. Tay and Sachs in the 1880's, was classified for over sixty years as a "degenerative disorder" of the central nervous system (CNS).

Approximately five years ago, however, it was shown that the disorder is due to the deficient activity of an enzyme, hexosaminidase A, which catabolizes a normally occurring ganglioside. The accumulation of this sphingolipid causes progressive CNS deterioration in an infant who previously developed normally for the first six-to-nine months of life. Death by the age of four or five is inevitable since no cure is available or imminent.

Over the past few years, an accurate procedure for the quantitation of hexosaminidase A (hex A) activity in serum has been developed which identifies the carriers of this autosomal recessive disorder. Because the Tay-Sachs disease occurs one hundred times as frequently in Ashkenazi Jews (those Jews of Eastern European and Russian ancestry who represent 90% of the United States Jews) as compared to Gentiles and Sephardic Jews, it has become feasible and advisable to use this test to screen this population for the carrier state. Identification of the carrier is important for the following reasons:

- 1) It alerts relatives of carriers (through appropriate genetic counseling) of their very high risk for also being a carrier;
- 2) It allows identification of couples in the childbearing age who may *both* have the abnormal gene and are therefore at a 1:4

risk for having a Tay-Sachs infant. If both members of a parent pair are carriers, three alternatives exist:

- a) limitation of family size;
- b) therapeutic termination of an involved fetus diagnosed by amniocentesis in the 4th month of pregnancy;
- c) artificial insemination from a male known *not* to be a Tay-Sachs carrier—this approach would only be suggested where amniocentesis or termination of pregnancy are not acceptable to the parents.

Over the past twenty months, the Departments of Pediatrics and Pathology at MCV, in cooperation with the Virginia State Health Department and concerned local physicians and volunteers, have organized intensive educational campaigns to outline the rationale of Tay-Sachs carrier testing. These efforts in Richmond, Roanoke, Norfolk-Virginia Beach, Hampton-Newport News, and Fredericksburg, have yielded a voluntary turnout of over 3600 adult Jews at designated testing dates in community centers.

Complete analysis of over 2000 specimens has thus far disclosed a carrier incidence of 1:30. This figure is in close agreement with the 1:28 figure found by the first and largest "outreach" Tay-Sachs screening program—that developed by Dr. Michael Kaback of the Johns Hopkins University Medical Center for the Baltimore-Washington area. Approximately a dozen other large cities have launched similar programs, but none has surpassed the Virginia experience in providing this testing to so many people over so large an area.

Of equal importance to education and testing in such a detection program is the availability of adequate counseling for the carrier. Professional genetic counselors have provided this service for every Tay-Sachs carrier in Virginia, including advice concerning the importance and method of testing at-risk relatives.

The ultimate national goal of such a carrier detection program is to avert the birth of Tay-Sachs children. This could be done most efficiently by testing *only* married Jewish couples in the child-bearing age prior to their planning any children. Because lack of funds and the complexity of the enzyme measurement presently prohibit the wide spread availability of the test, however, this is not feasible in most areas of the country. Logic dictates, therefore, that the best alternative is first

to identify which families (in cities where the test is available) carry the gene abnormality and then to urge testing for high-risk relatives residing in smaller cities where screening is not available. The MCV Tay-Sachs Screening Program has received frozen serum from as distant a city as Niagara Falls, New York, where the relative of a Richmond carrier resided.

For further information regarding the MCV Tay-Sachs Screening Program, contact either Dr. Peter Mamunes or Dr. Seymour Bakerman by writing to Box 187, Medical College of Virginia, Richmond 23298, or by telephoning 804-770-3033.

Sickle cell disease differs from Tay-Sachs disease in many ways. From the standpoint of carrier detection programs, however, the most important differences are that:

- 1) The test is much simpler and blood specimens can be mailed into a central laboratory;
- 2) The carrier rate is considerably higher—approximately 1:12;
- 3) *No prenatal test is available* when both parents are known carriers.

For these reasons, a greater effort of education and testing at an earlier age are indicated.

Much of the screening for sickle cell trait in the state of Virginia is accomplished by the Virginia Sickle Cell Anemia Awareness Program (VaSCAP) of the Medical College of Virginia, and the sickle cell program of the State Health Department. The purposes of these programs are to educate the public, to provide a screening for young people who wish to know whether they carry the recessive trait for sickling, and to provide counseling for those who have been tested.

The VaSCAP program at the Medical College of Virginia tests young people in the child-bearing age, as well as premarital blood samples when the test is desired. A total of 11,000 specimens per year have been screened, many of them from the Richmond metropolitan area. The laboratory of the State Health Department has a capacity for up to 40,000 tests a year and collects samples from all over the state from individuals of any age.

The VaSCAP program at MCV also provides educational services for the school systems in greater Richmond and other outlying areas, as well as educational programs for organizations and health clinics where it is requested. Screening programs

are provided for public schools and colleges in the area, and counseling programs are offered for individuals tested in the program. In addition, the VaSCAP program has provided a series of seminars for public health nurses throughout the state to teach a larger number of individuals the principles of counseling for sickle cell trait.

The offices of the Virginia Sickle Cell Anemia Awareness Program are at 1008 East Clay Street, Richmond, Virginia 23298, and the program is supervised by Mrs. Florence Cooper. The telephone

number is 770-7797. The program of the State Health Department is directed by Dr. Patricia Hunt, Director, Bureau of Child Health, with offices in the Madison Building in Richmond.

Carrier detection programs, such as those above described, have proven that the public will voluntarily present themselves for testing if there is appropriate precedent education and follow-up counseling. Every physician should acquaint himself with these recently available services and join the effort to reduce the incidence of these dreadful disorders.

A Message to Our Readers:

The *MCV/Q* is now in its tenth year of publication. Since its inception, its quality has shown continual improvement and its circulation has quadrupled. Despite an increase in advertising revenue, however, we are unable to meet the increased costs of publication, and we are now faced with severe budget restrictions. After this issue, therefore, our gratis distribution will be limited to alumni, faculty, and students of MCV/VCU, although we hope that many of these readers will make voluntary contributions or subscribe to the *MCV/Q*.

Regretfully, but with an eye to survival, we must ask all others who wish to continue to receive the *MCV/Q*, to subscribe at the prices quoted on page 7. We hope that you regard this publication as well worth the modest cost. To assure that you do not miss the next issue, which will present a second selection of the papers given at the McGuire Lecture Series, and succeeding issues for this year, presenting the 27th Annual Stoneburner Lectures on "Clinical Advances in Medical and Surgical Neurology," please take a minute to complete the order form provided herein and mail it as soon as possible.



A service to medical education from A. H. Robins:

Excerpted from Volume 2

of the
G.I. Series

on physical examination
of the abdomen:

Normally palpable organs:

the edge of the liver descending, on inspiration, below the costal margin (A); the lower pole of the right kidney (B); the abdominal aorta (C); the descending colon and the sigmoid (D); the ascending colon (E); and occasionally the bladder (though rising of this organ beyond the pubis does not necessarily indicate disease).

Impossible to outline, unless diseased, distended or enlarged: the gallbladder, pancreas, stomach, small intestine, transverse colon and spleen.

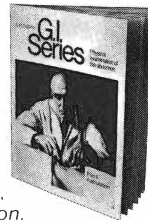

The A. H. Robins G.I. Series consists of six booklets, designed to provide a quick, yet comprehensive review of basic procedures and practices in G.I. medicine—with particular emphasis on the physical examination as performed in the office or at bedside. If you have teaching responsibilities, limited quantities are available: Part 1—*Inspection*, Part 2—*Palpation*, Part 3—*Percussion*, Part 4—*Auscultation*, Part 5—*Abdominal Pain* and Part 6—*Differential Diagnosis of Abdominal Disorders*. Write to: The Medical Department, A. H. Robins Company, 1407 Cummings Drive, Richmond, Virginia 23220.

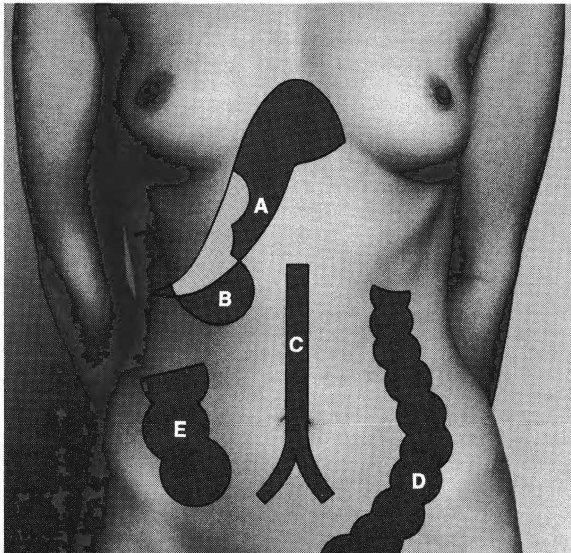

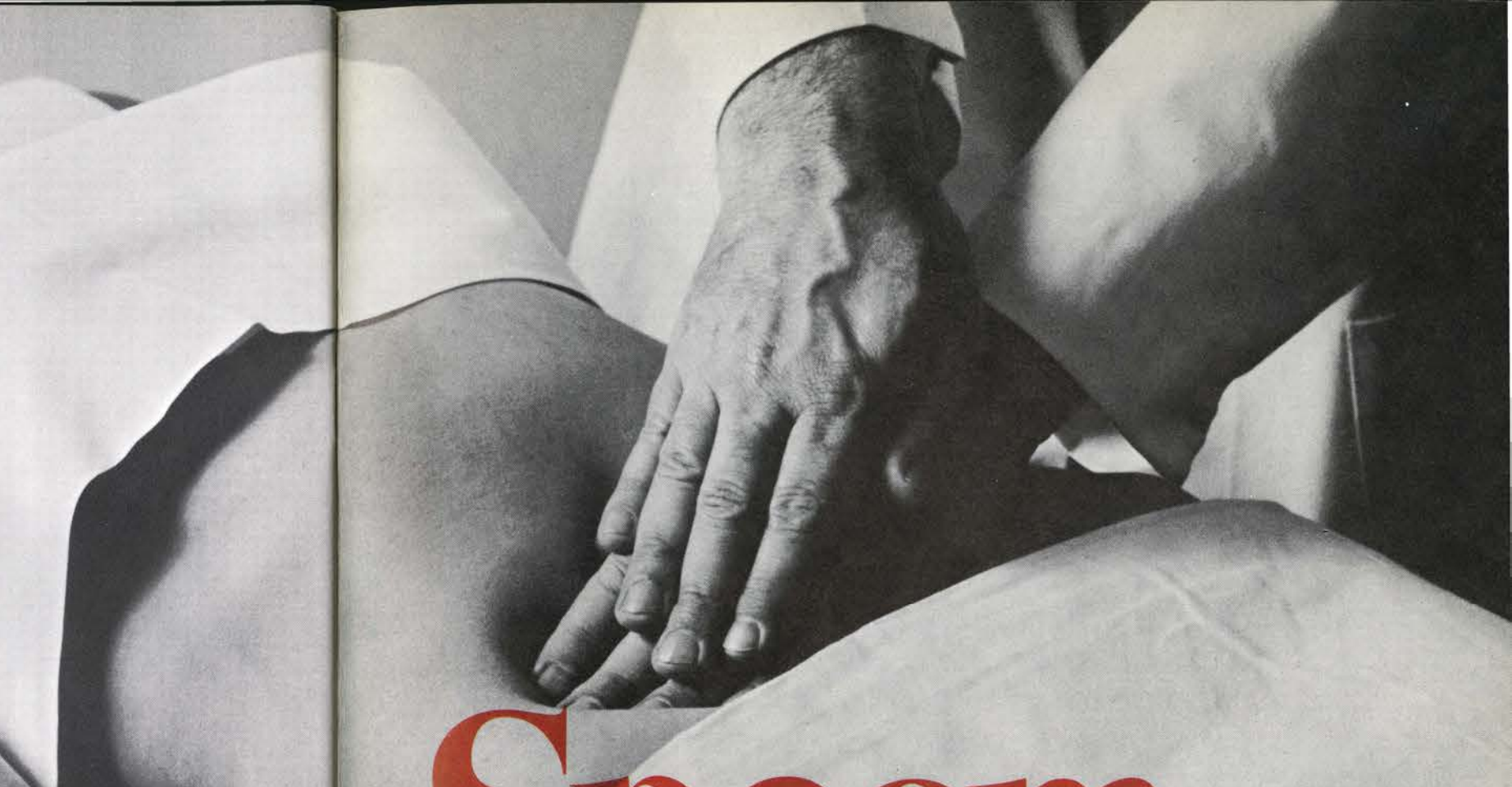

A service to medical education from A. H. Robins:

Excerpted from Volume 2
of the **G.I. Series**

on physical examination
of the abdomen:

The A. H. Robins G.I. Series consists of six booklets, designed to provide a quick, yet comprehensive review of basic procedures and practices in G.I. medicine—with particular emphasis on the physical examination as performed in the office or at bedside. If you have teaching responsibilities, limited quantities are available: Part 1—*Inspection*, Part 2—*Palpation*, Part 3—*Percussion*, Part 4—*Auscultation*, Part 5—*Abdominal Pain* and Part 6—*Differential Diagnosis of Abdominal Disorders*. Write to: The Medical Department, A. H. Robins Company, 1407 Cummings Drive, Richmond, Virginia 23220.

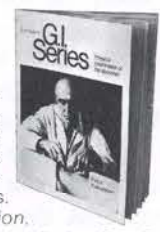

Normally palpable organs: the edge of the liver descending, on inspiration, below the costal margin (A); the lower pole of the right kidney (B); the abdominal aorta (C); the descending colon and the sigmoid (D); the ascending colon (E); and occasionally the bladder (though rising of this organ beyond the pubis does not necessarily indicate disease).

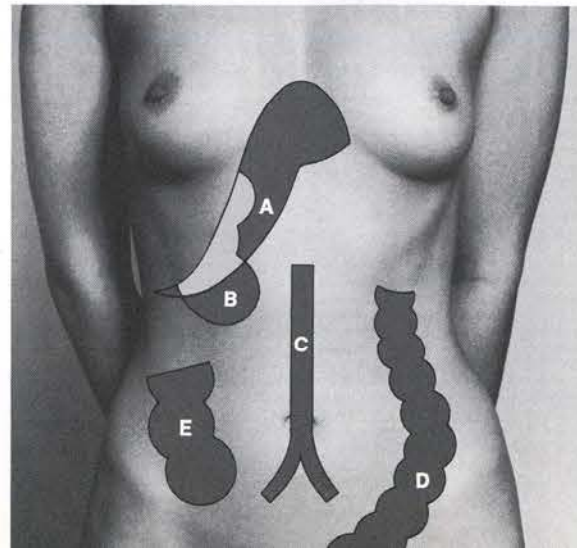

Impossible to outline, unless diseased, distended or enlarged: the gallbladder, pancreas, stomach, small intestine, transverse colon and spleen.

Spasm reactor?

Donnatal!

	each tablet, capsule or 5 cc. teaspoonful of elixir (23% alcohol)	each Donnatal No. 2	each Extentab
hyoscyamine sulfate	0.1037 mg.	0.1037 mg.	0.3111 mg.
atropine sulfate	0.0194 mg.	0.0194 mg.	0.0582 mg.
hyoscine hydrobromide	0.0065 mg.	0.0065 mg.	0.0195 mg.
phenobarbital	($\frac{1}{4}$ gr.) 16.2 mg.	($\frac{1}{2}$ gr.) 32.4 mg.	($\frac{3}{4}$ gr.) 48.6 mg.

(warning: may be habit forming)

Brief summary. Adverse Reactions: Blurring of vision, dry mouth, difficult urination, and flushing or dryness of the skin may occur on higher dosage levels, rarely on usual dosage. Contraindications: Glaucoma; renal or hepatic disease; obstructive uropathy (for example, bladder neck obstruction due to prostatic hypertrophy); or hypersensitivity to any of the ingredients.

A-H-ROBINS A. H. Robins Company, Richmond, Virginia 23220



Spasm reactor?

Donnatal!®

	each tablet, capsule or 5 cc. teaspoonful of elixir (23% alcohol)	each Donnatal No. 2	each Extentab
hyoscyamine sulfate	0.1037 mg.	0.1037 mg.	0.3111 mg.
atropine sulfate	0.0194 mg.	0.0194 mg.	0.0582 mg.
hyoscine hydrobromide	0.0065 mg.	0.0065 mg.	0.0195 mg.
phenobarbital	($\frac{1}{4}$ gr.) 16.2 mg.	($\frac{1}{2}$ gr.) 32.4 mg.	($\frac{3}{4}$ gr.) 48.6 mg.

(warning: may be habit forming)

Brief summary. Adverse Reactions: Blurring of vision, dry mouth, difficult urination, and flushing or dryness of the skin may occur on higher dosage levels, rarely on usual dosage. Contraindications: Glaucoma; renal or hepatic disease; obstructive uropathy (for example, bladder neck obstruction due to prostatic hypertrophy); or hypersensitivity to any of the ingredients.

A-H-ROBINS A. H. Robins Company, Richmond, Virginia 23220

Before prescribing, please consult complete product information, a summary of which follows:

Indications: Tension and anxiety states, somatic complaints which are concomitants of emotional factors; psychoneurotic states manifested by tension, anxiety, apprehension, fatigue, depressive symptoms or agitation; symptomatic relief of acute agitation, tremor, delirium tremens and hallucinosis due to acute alcohol withdrawal; adjunctively in skeletal muscle spasm due to reflex spasm to local pathology, spasticity caused by upper motor neuron disorders, athetosis, stiff-man syndrome, convulsive disorders (not for sole therapy).

Contraindicated: Known hypersensitivity to the drug. Children under 6 months of age. Acute narrow angle glaucoma; may be used in patients with open angle glaucoma who are receiving appropriate therapy.

Warnings: Not of value in psychotic patients. Caution against hazardous occupations requiring complete mental alertness. When used adjunctively in convulsive disorders, possibility of increase in frequency and/or severity of grand mal seizures may require increased dosage of standard anticonvulsant medication; abrupt withdrawal may be associated with temporary increase in frequency and/or severity of seizures. Advise against simultaneous ingestion of alcohol and other CNS depressants. Withdrawal symptoms (similar to those with barbiturates and alcohol) have occurred following abrupt discontinuance (convulsions, tremor, abdominal and muscle cramps, vomiting and sweating). Keep addiction-prone individuals under careful surveillance because of their predisposition to habituation and dependence. In pregnancy, lactation or women of childbearing age, weigh potential benefit against possible hazard.

Precautions: If combined with other psychotropics or anticonvulsants, consider carefully pharmacology of agents employed; drugs such as phenothiazines, narcotics, barbiturates, MAO inhibitors and other antidepressants may potentiate its action. Usual precautions indicated in patients severely depressed, or with latent depression, or with suicidal tendencies. Observe usual precautions in impaired renal or hepatic function. Limit dosage to smallest effective amount in elderly and debilitated to preclude ataxia or oversedation.

Side Effects: Drowsiness, confusion, diplopia, hypotension, changes in libido, nausea, fatigue, depression, dysarthria, jaundice, skin rash, ataxia, constipation, headache, incontinence, changes in salivation, slurred speech, tremor, vertigo, urinary retention, blurred vision. Paradoxical reactions such as acute hyperexcited states, anxiety, hallucinations, increased muscle spasticity, insomnia, rage, sleep disturbances, stimulation have been reported; should these occur, discontinue drug. Isolated reports of neutropenia, jaundice; periodic blood counts and liver function tests advisable during long-term therapy.

If there's good reason to prescribe for psychic tension...



When, in spite of counseling,
the patient's pattern of overreaction to stress
affects his ability to function

Dependable response is a good reason to consider Valium® (diazepam)

2-mg, 5-mg,
10-mg tablets



Roche Laboratories
Division of Hoffmann-La Roche Inc.
Nutley, N.J. 07110